

IOMI: 17 873 0000 08/22 Rev H

Preventative Maintenance Guide: 17 873 0007

Compressed Air Dryers

Medium Flow Dryers

CDAS HL 050 - CDAS HL 085

OFAS HL 050 - OFAS HL 085

FBP HL 050 - FBP HL 085



Installation, Operation and
Maintenance Instructions

(EN)



CONTENTS

- 05** - Safety Information
- 06** - Markings and Symbols
 - Dryer Model Number Identification
- 08** - Receiving and Inspecting the Equipment
 - Storage
 - Unpacking
- 10** - Model Overview
- 14** - Overview of the Equipment
- 18** - Installation and Commissioning
 - Commissioning Check List
- 19** - Recommended System Layout
- 20** - Locating the Equipment
 - Mechanical Installation
- 22** - Electrical Installation
 - Dryer Electrical Supply
 - Commissioning - Controller Setup Basic Operation
- 23** - Configure Inlet Valves Configuration (N/C or N/O)
 - Configure Temperature Units to be Displayed
- 24** - Commissioning - Controller Setup Advanced Installation
 - CDAS HL / OFAS HL / FBP HL Dryer Auxiliary Connections
- 25** - Remote Stop / Start Connections
 - Remote Stop / Start Operation
- 26** - Purge Economy Connection
- 27** - Purge Economy Operation
- 28** - Remote Alarm Connection - General Fault Alarm
 - Remote Alarm Connection Operation

CONTENTS

- 29** - Remote Alarm Connection - Dedicated Dewpoint Alarm
- 30** - 4-20mA Dewpoint Retransmission
- 31** - Using the 4-20mA Signal
- 32** - MODBUS Connectivity
- 33** - MODBUS Strings
- 35** - Changing MODBUS Communication Settings via ADS Service Software
- 37** - Overview of Operation
- 38** - CDAS HL / OFAS HL / FBP HL Operation
- 43** - Operating the Dryer
 - Displays and Indicators
- 52** - Service Intervals
- 53** - Preventative Maintenance Kits
- 59** - Technical Specification
- 61** - Approvals Compliance and Exemptions
- 62** - Weights and Dimensions
- 65** - Trouble shooting

SAFETY

SAFETY INFORMATION

Do not operate this equipment until the safety information and instructions in this user guide have been read and understood by all personnel concerned.

USER RESPONSIBILITY

FAILURE OR IMPROPER SELECTION OR IMPROPER USE OF THE PRODUCTS DESCRIBED HEREIN OR RELATED ITEMS CAN CAUSE DEATH, PERSONAL INJURY AND PROPERTY DAMAGE.

This document and other information from Parker-Hannifin Corporation, its subsidiaries and authorised distributors provide product or system options for further investigation by users having technical expertise.

The user, through its own analysis and testing, is solely responsible for making the final selection of the system and components and assuring that all performance, endurance, maintenance, safety and warning requirements of the application are met. The user must analyse all aspects of the application, follow applicable industry standards, and follow the information concerning the product in the current product catalogue and in any other materials provided from Parker or its subsidiaries or authorised distributors.

To the extent that Parker or its subsidiaries or authorised distributors provide component or system options based upon data or specifications provided by the user, the user is responsible for determining that such data and specifications are suitable and sufficient for all applications and reasonably foreseeable uses of the components or systems.

The pressure envelope of the generator must not be breached under any circumstances. Failure to comply may result in an unplanned release of pressure, and may cause serious personal injury or death. All maintenance procedures that require the pressure envelope to be breached must only be performed by competent personnel trained, qualified, and approved by Parker.

Use of the equipment in a manner not specified within this user guide may result in an unplanned release of pressure, which may cause serious personal injury or damage.

When handling, installing or operating this equipment, personnel must employ safe engineering practices and observe all related regulations, health & safety procedures, and legal requirements for safety.

Ensure that the equipment is depressurised and electrically isolated, prior to carrying out any of the scheduled maintenance instructions specified within this user guide.

Only competent personnel trained, qualified, and approved by Parker should perform installation, commissioning, service and repair procedures.

Parker can not anticipate every possible circumstance which may represent a potential hazard. The warnings in this manual cover the most known potential hazards, but by definition can not be all-inclusive. If the user employs an operating procedure, item of equipment or a method of working which is not specifically recommended by Parker the user must ensure that the equipment will not be damaged or become hazardous to persons or property.













Most accidents that occur during the operation and maintenance of machinery are the result of failure to observe basic safety rules and procedures. Accidents can be avoided by recognising that any machinery is potentially hazardous.

Details of your nearest Parker sales office can be found at www.parker.com/gsfe

Retain this user guide for future reference.

MARKINGS AND SYMBOLS

The following markings and international symbols are used on the equipment or within this user guide:

	Caution, Read the User Guide.		Wear ear protection.
	Risk of electric shock.		Pressurised components on the system.
 Warning	Highlights actions or procedures which, if not performed correctly, may lead to personal injury or death.		Remote control. Dryer may start automatically without warning.
 Caution	Highlights actions or procedures which, if not performed correctly, may lead to damage to this product.		Conformité Européenne
 Warning	Highlights actions or procedures which, if not performed correctly, could lead to electric shock.		Dispose in accordance with local regulations
	Read the User Guide.		Safety gloves to be worn
	Energy Saving		Use a forklift truck to move the generator

DRYER MODEL NUMBER IDENTIFICATION

			050					
			055					
			060					
			065					
			070					
CDAS			075	-20				
OFAS			080	-40	G (BSPP)			
FBP	HL (Heatless)		085	-70	N (NPT)	16	A (AC 85-265V 50/60Hz)	Electronic

	SERIES	REGEN TYPE	MODEL	DEWPOINT	CONNECTIONS	MAX PRESSURE	POWER SUPPLY	CONTROLLER
Example	CDAS	HL	050	-40	G	16	A	E

RECEIVING AND INSPECTING THE EQUIPMENT

RECEIVING AND INSPECTING THE EQUIPMENT

The dryer is supplied in a sturdy wooden crate designed to be moved using a forklift truck or pallet truck. Refer to the technical specification for packed weights and dimensions. On delivery of the equipment check the crate and its contents for damage. If there are any signs of damage to the crate, or there are any parts missing please inform the delivery company immediately and contact your equipment supplier or local Parker sales company.

Transportation

The equipment must be kept upright at all times, including during transportation, storage and unpacking.

Storage

The equipment should be stored, within the packing crate, in a clean dry environment. If the crate is stored in an area where the environmental conditions fall outside of those specified in the technical specification, it should be moved to its final location (installation site) and left to stabilise prior to unpacking. Failure to do this could cause condensing humidity and potential failure of the equipment.

Unpacking

Remove the lid (A) and then all four sides of the packing crate (B). Carefully move the dryer to its final location, using a forklift truck or pallet truck.

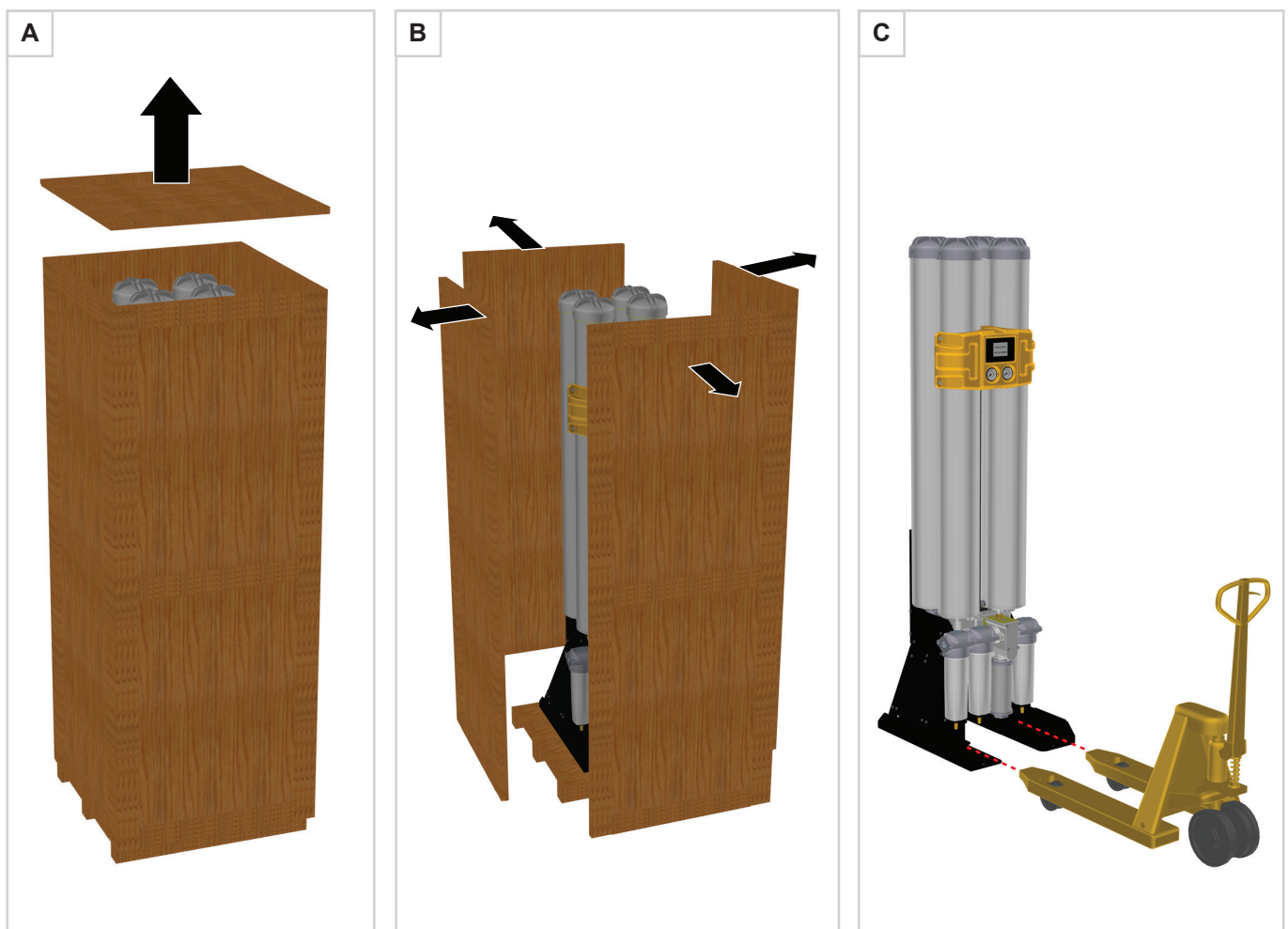

MODEL OVERVIEW

Model Overview

CDAS HL / OFAS HL / FBP HL are complete purification systems designed to reduce the major contaminants found in a compressed air system and deliver air purity that meets or exceeds the highest classifications of ISO 8573-1:2010 (the international standard for compressed air purity).

RANGE		Number of Contaminants Treated (With Optional Water Separator)	Number of Purification Stages (With Optional Water Separator)	ISO 8573-1:2010 Classification (Pressure Dewpoint)		
CDAS	Clean Dry Air System	7 (9)	4 (5)	2:3:2 (≤-20°C)	2:2:2 (≤-40°C)	2:1:2 (≤-70°C)

MODEL: CDAS - CLEAN DRY AIR SYSTEM

1
General Purpose Coalescing Filter
 For the reduction of water and oil aerosols down to 0.5mg/m³ and particulate down to 1 micron.
 Provides protection of the High Efficiency Coalescing Filter and Dryer.

2
High Efficiency Coalescing Filter
 For the reduction of water and oil aerosols down to 0.01mg/m³ and particulate down to 0.01 micron
 Provides protection for the Dryer

3
Adsorption Dryer
 For the reduction of water vapour
 Standard PDP ≤-40°C
 Option
 ≤-70°C PDP or ≤-20°C PDP



4
General Purpose Dry Particulate Filter
 For the reduction of particulate down to 1 micron

MODEL: OFAS - OIL FREE AIR SYSTEM

RANGE		Number of Contaminants Treated (With Optional Water Separator)	Number of Purification Stages (With Optional Water Separator)	ISO 8573-1:2010 Classification (Pressure Dewpoint)		
OFAS	Oil Free Air System	8 (10)	5 (6)	2:3:0 ($\leq -20^{\circ}\text{C}$)	2:2:0 ($\leq -40^{\circ}\text{C}$)	2:1:0 ($\leq -70^{\circ}\text{C}$)

1

General Purpose Coalescing Filter

For the reduction of water and oil aerosols down to 0.5 mg/m^3 and particulate down to 1 micron.

Provides protection of the High Efficiency Coalescing Filter and Dryer.

2

High Efficiency Coalescing Filter

For the reduction of water and oil aerosols down to 0.01 mg/m^3 and particulate down to 0.01 micron

Provides protection for the Dryer

3

Adsorption Dryer

For the reduction of water vapour

Standard PDP $\leq -40^{\circ}\text{C}$

Option $\leq -70^{\circ}\text{C}$ PDP or $\leq -20^{\circ}\text{C}$ PDP



4

Oil Vapour Reduction Filter

For the reduction of oil vapour down to $\leq 0.003 \text{ mg/m}^3$

5

General Purpose Dry Particulate Filter

For the reduction of particulate down to 1 micron

MODEL: FBP - FOOD BEVERAGE PHARMACEUTICAL

RANGE		Number of Contaminants Treated (With Optional Water Separator)	Number of Purification Stages (With Optional Water Separator)	ISO 8573-1:2010 Classification (Pressure Dewpoint)		
FBP	Food Beverage Pharmaceutical	8 (10)	6 (7)	-	1:2:0 (≤-40°C)	1:1:0 (≤-70°C)

1
General Purpose Coalescing Filter
 For the reduction of water and oil aerosols down to 0.5 mg/m³ and particulate down to 1 micron.
 Provides protection of the High Efficiency Coalescing Filter and Dryer.

2
High Efficiency Coalescing Filter
 For the reduction of water and oil aerosols down to 0.01 mg/m³ and particulate down to 0.01 micron
 Provides protection for the Dryer

3
Adsorption Dryer
 For the reduction of water vapour
 Standard PDP ≤-40°C
 Option
 ≤-70°C PDP or ≤-20°C PDP

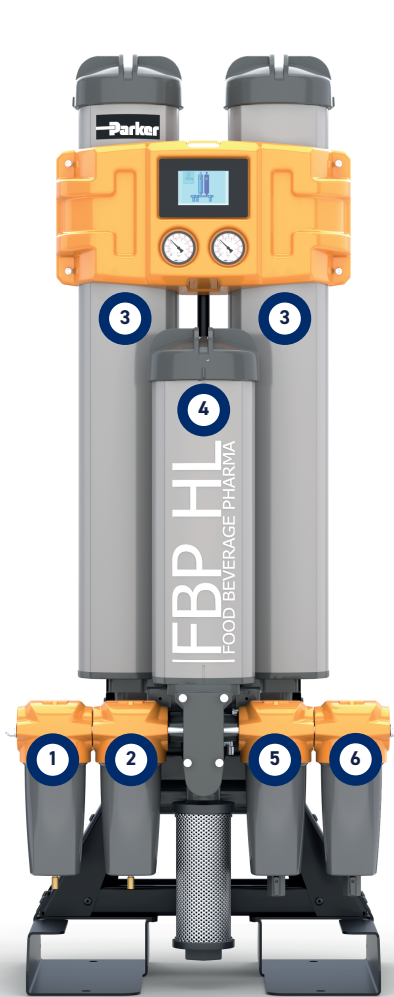

4
Oil Vapour Reduction Filter
 For the reduction of oil vapour down to ≤0.003 mg/m³

5
General Purpose Dry Particulate Filter
 For the reduction of particulate down to 1 micron

6
High Efficiency Dry Particulate Filter
 For the reduction of particulate and micro-organisms down to 0.01 micron with an efficiency of 99.9999%

OVERVIEW OF THE EQUIPMENT

OVERVIEW OF THE EQUIPMENT

CDAS - Clean Dry Air System

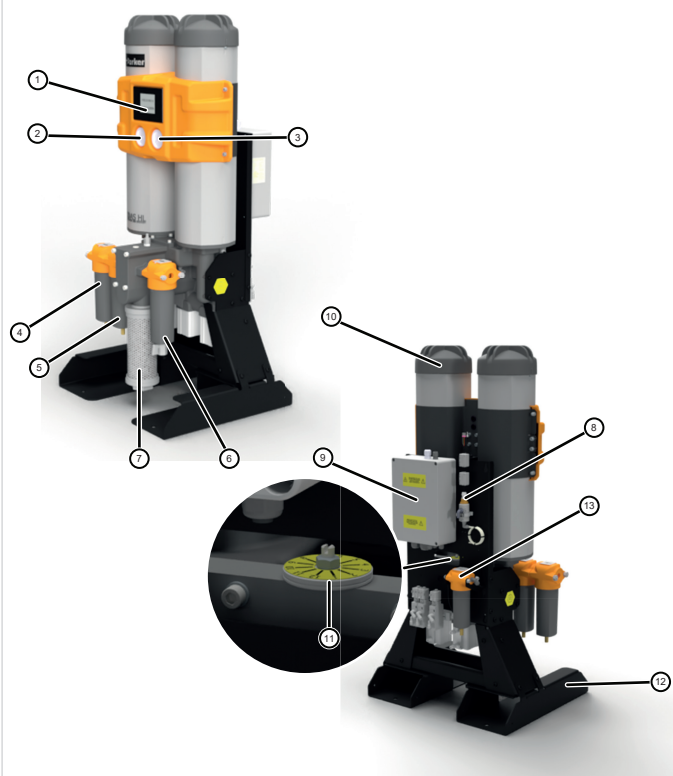

Representation of Models CDAS HL050 to CDAS HL070

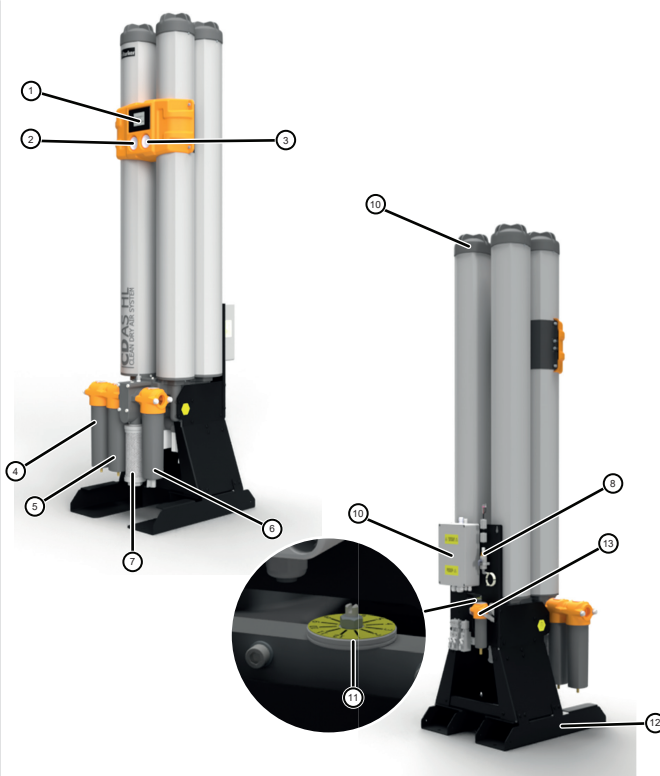

Representation of Models CDAS HL075 to CDAS HL085

REF	DESCRIPTION	REF	DESCRIPTION
1	Display	8	Dewpoint sensor
2	Column 1 pressure gauge	9	Control box
3	Column 2 pressure gauge	10	Column caps
4	General purpose coalescing filter (Grade AO)	11	Adjustable purge disc
5	High efficiency coalescing filter (Grade AA)	12	Pallet truck lifting points
6	General purpose dry particulate filter (Grade AO)	13	Control valve filter (Grade AA)
7	Exhaust silencer		

OFAS - Oil Free Air System

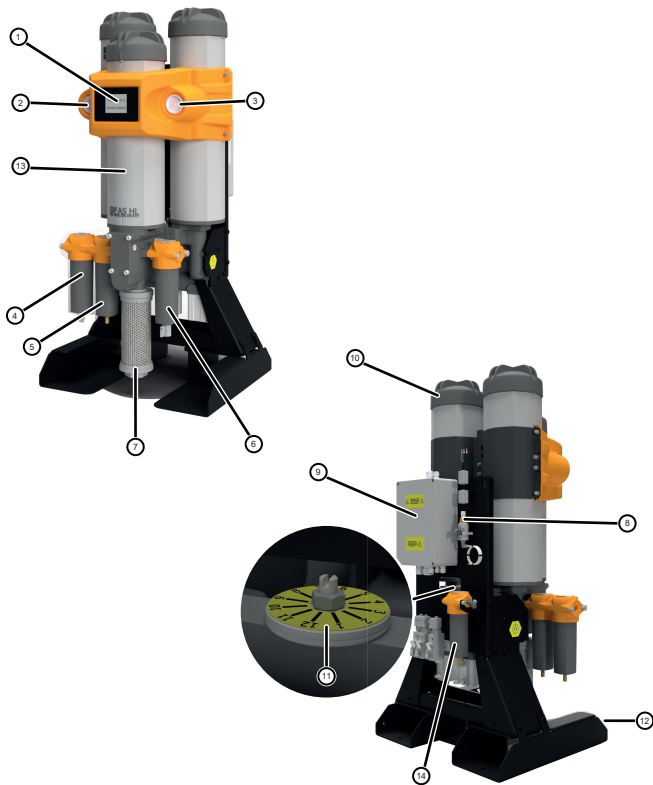

Representation of Models OFAS HL050 to OFAS HL070



Representation of Models OFAS HL075 to OFAS HL085

REF	DESCRIPTION	REF	DESCRIPTION
1	Display	8	Dewpoint sensor
2	Column 1 pressure gauge	9	Control box
3	Column 2 pressure gauge	10	Column caps
4	General purpose coalescing filter (Grade AO)	11	Adjustable purge disc
5	High efficiency coalescing filter (Grade AA)	12	Pallet truck lifting points
6	General purpose dry particulate filter (Grade AO)	13	Oil vapour reduction stage
7	Exhaust silencer	14	Control valve filter (Grade AA)

FBP - Food Beverage Pharmaceutical

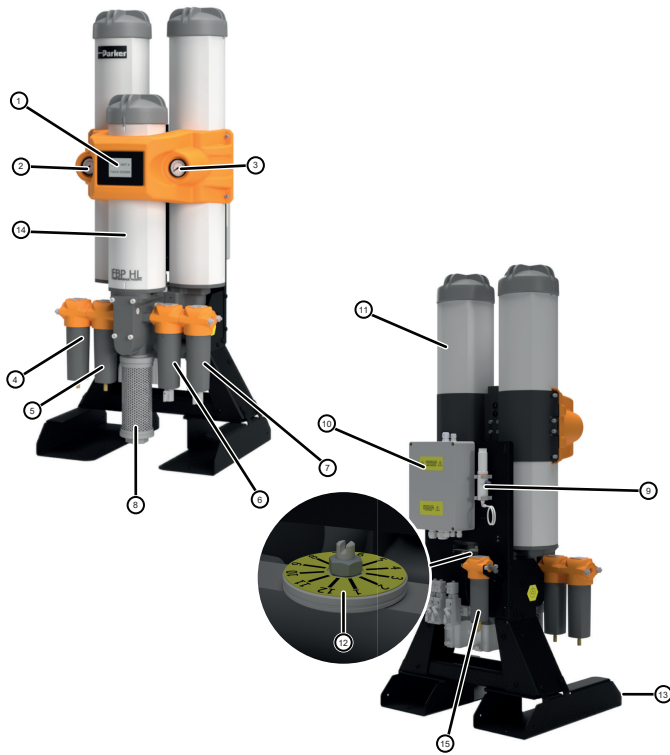

Representation of Models FBP HL050 to FBP HL070

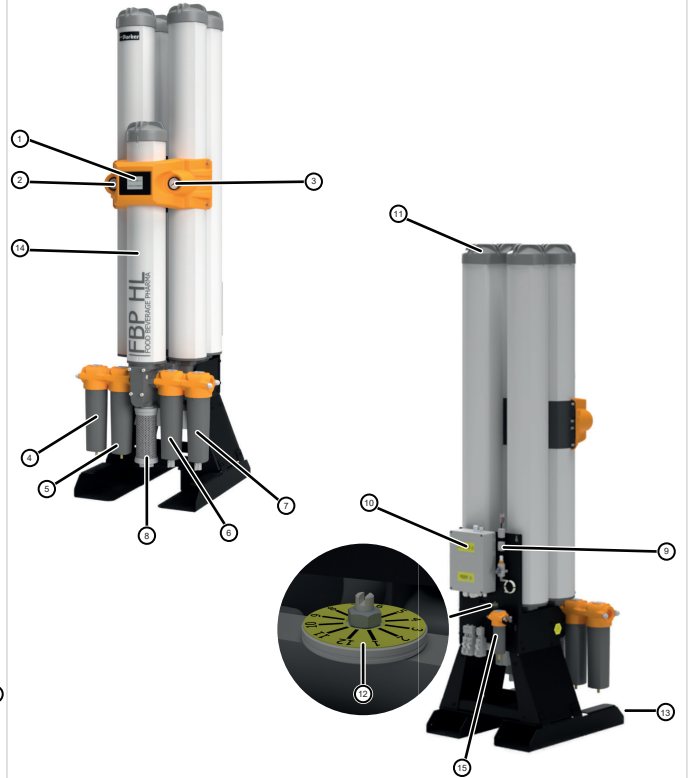

Representation of Models FBP HL075 to FBP HL085

REF	DESCRIPTION	REF	DESCRIPTION
1	Display	9	Dewpoint sensor
2	Column 1 pressure gauge	10	Control box
3	Column 2 pressure gauge	11	Column caps
4	General purpose coalescing filter (Grade AO)	12	Adjustable purge disc
5	High efficiency coalescing filter (Grade AA)	13	Pallet truck lifting points
6	General purpose dry particulate filter (Grade AO)	14	Oil vapour reduction stage
7	High efficiency dry particulate filter (Grade AA)	15	Control valve filter (Grade AA)
8	Exhaust silencer		

INSTALLATION AND COMMISSIONING

INSTALLATION AND COMMISSIONING



Only competent personnel trained, qualified, and approved by Parker Hannifin should perform installation, commissioning, service and repair procedures.

Warning

COMMISSIONING CHECK LIST

TASK	PAGE	COMMENTS	TICK WHEN OK
Recommended System Layout			
System Components / piping installation	19		
Locating the Equipment			
Installation Environment	20		
Ensure adequate space for installation / maintenance	20		
Mechanical Installation	20		
Set purge for minimum inlet pressure	21		
Electrical Installation			
Dryer electrical connection	22		
Commissioning - Controller Basic Installation			
Configure Dewpoint Setpoint / ECO Setpoint / Dewpoint Alarm Setpoint	22		
Configure Inlet Valve Configuration - Normally Open / Normally Closed	23		
Configure Temperature Units to be Displayed - °C or °F	23		
Commissioning - Controller Setup Advanced Installation			
Remote Stop / Start Connection	25		
Purge Economy Connection	26		
Remote Alarm Connection - General Fault Alarm Relay	28		
Remote Alarm Connection - Addition of a Dedicated Dewpoint Alarm Relay	29		
4-20mA Dewpoint Retransmission	30		
MODBUS Connectivity	32		
MODBUS Strings	33		
MODBUS Setup via ADS Software	34		
Final Check			
Pressurisation / Leak check	N/A		
Operation			
Dryer start-up procedure	45		
Monitor operation / performance			
Troubleshooting (if required)	64		
Installation and Commissioning Complete			

RECOMMENDED SYSTEM LAYOUT

CDAS HL / OFAS HL / FBP HL dryers can be installed directly after an air compressor or downstream of a wet air receiver. The preferred method of installation is downstream of a wet air receiver as the air receiver acts as a pre-cooler / liquid separator and is effective at protecting the dryer from bulk liquid contamination and small temperature spikes.

Water Separator (Optional)

Should CDAS HL / OFAS HL / FBP HL be installed directly after the air compressor (no wet air receiver) or the distance from the outlet of the wet air receiver is >3m, an optional OIL-X Grade WS water separator should be installed. Water separators are used to protect the coalescing filters included with CDAS HL / OFAS HL / FBP HL from liquid contamination. If liquid water / oil is not treated prior to the dryer, dewpoint performance may not be achieved, and any remaining warranty will be invalidated.

General Purpose and High Efficiency Coalescing Filters (included)

Coalescing filters are probably the single most important items of purification equipment in a compressed air system. They are designed to not only reduce aerosols (droplets) of oil and water using mechanical filtration techniques, but also to reduce solid particulate to very low levels (as small as 0.01micron in size). Installed in pairs, the first filter is a 'General Purpose Filter' which protects the second 'High Efficiency Filter' from bulk contamination. The included dual filter installation ensures a continuous supply of high quality compressed air with the additional benefits of low operational costs and minimal maintenance.

Dry Particulate Filters (included)

CDAS HL / OFAS HL / FBP HL dryers include either a single Dry Particulate Filter (CDAS HL / OFAS HL) or a pair of Dry Particulate Filters (OFAS HL) for the reduction of desiccant particulates (and micro-organisms on FBP dryers). They provide identical particulate reduction performance to the equivalent coalescing filter and use the same mechanical filtration techniques to provide particle reduction.

Important Note

Failure maintain the pre and post filtration supplied with the dryer will invalidate the dryer's warranty.

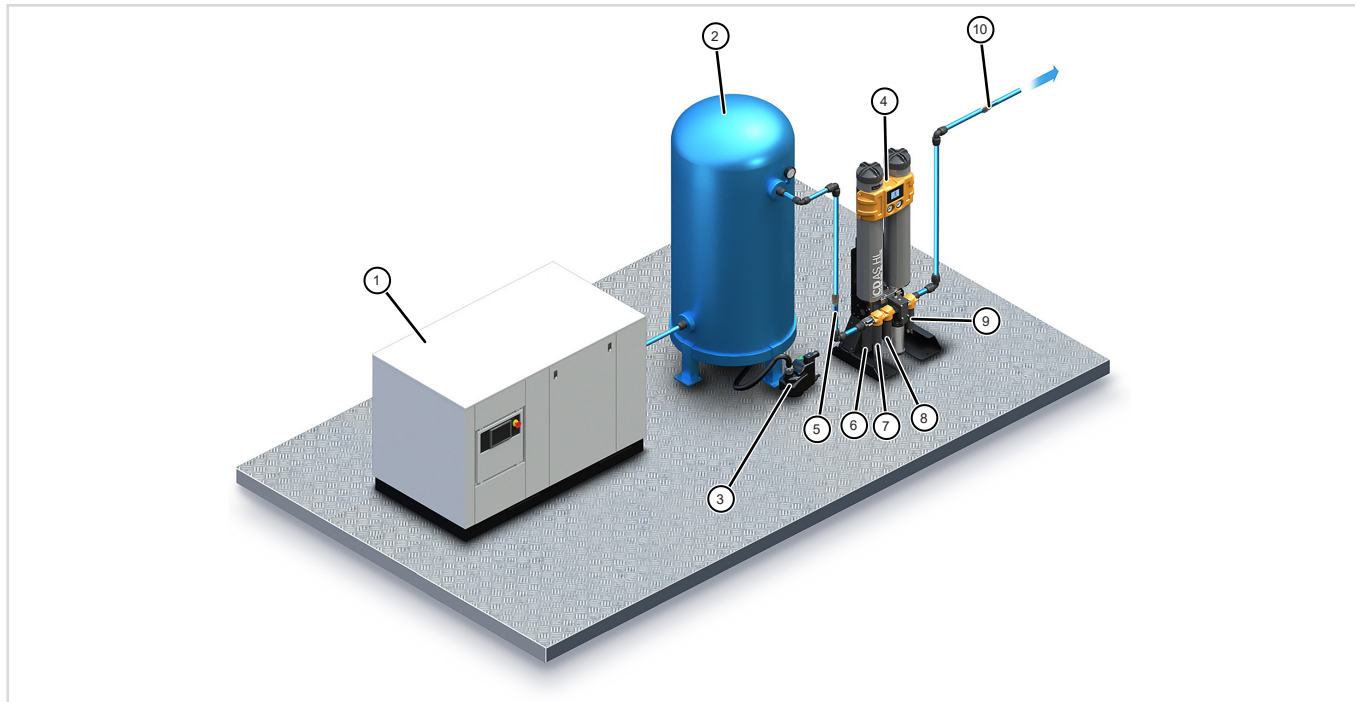

REF	DESCRIPTION	REF	DESCRIPTION
1	Compressor	6	Water Separator (Optional)
2	Wet Air Receiver	7	General Purpose Coalescing Filter
3	Electronic Condensate Drain (Not Included)	8	High Efficiency Coalescing Filter
4	Medium Flow Dryer	9	General Purpose Dry Particulate Filter
5	Isolation Valve (Not Included)	10	Non-Return Valve (Not Included)

Important Notes: Protecting The Dryer from Reverse Flow

- Compressed air dryers are designed to flow in one direction only.
- Back flow (reverse flow) must not be allowed or damage to the filtration and dryer may occur.
- The installation of a Non-Return Valve will stop reverse flow and prevent damage to the dryer.
- CDAS/OFAS/FBP models up to serial number **22CDAS08531** require an additional Non Return Valve at the outlet of the dryer (not supplied)
- CDAS/OFAS/FBP models from serial number **22CDAS08532** include an integral Non Return Valve (additional NRV not required)

LOCATING THE EQUIPMENT

Environment

The equipment should be located indoors in an environment that protects it from direct sunlight, moisture, and dust. Changes in temperature, humidity, and airborne pollution will affect the environment in which the equipment is operating and may impair the safety and operation. It is the customers' responsibility to ensure that the environmental conditions specified for the equipment are maintained.

Space Requirements

The equipment should be mounted on a flat surface capable of supporting its own weight plus the weight of all ancillary parts. There must be adequate space around the equipment to allow airflow and access for maintenance purposes and lifting equipment. A minimum spacing of approximately 500mm (20 ins) is recommended around all sides of the dryer and 750mm (29.5 ins) above it for the removal of the desiccant cartridges.

Do Not position the equipment so that it is difficult to operate or disconnect from the electrical supply.

MECHANICAL INSTALLATION

General Requirements

Ensure that each condensate drain is suitably piped away and any effluent is disposed of in a legal and responsible manner and in accordance with local environmental regulations. Condensate drain lines should never be connected together - connect to a common, vented condensate manifold. Condensate drain lines should be of large internal diameter and short length to eliminate back pressure which would prevent drainage of condensate. Condensate discharged from water separator and filter float drains will lose pressure once it enters the piping. Installing drain lines at height will result in a failure to remove condensate and loss of dryer dewpoint.

Important Notes:

- Dryer performance may be degraded and warranty will be invalid if above requirements are not followed.
- It is important to ensure that all inlet and outlet piping materials are suitable for the application, clean and debris free.
- The internal diameter of the inlet and outlet piping must be sufficient to allow an unrestricted air flow into and out of the equipment .
- When routing, the piping, ensure that they are adequately supported to prevent damage and leaks in the system.



Warning

The system must be protected with a suitably rated thermal pressure relief valve.

SIDE MOUNTING THE REAR PANEL

For installations where space is limited (for example if the dryer is placed against a wall), it may be beneficial to install the rear panel assembly to the side of the dryer to provide easier access to the electrical control box, dewpoint sensor & control valves.

Important Notes:

- Piping between the 5/2 valves and cylinders requires exchanging with longer piping (not supplied). The length of piping required is tabled below.
- The values quoted are for the longest hose needed and for certain models may be trimmed shorter for neatness.

	Dryers manufactured prior to 05/10/2021			Dryers manufactured after to 05/10/2021		
	Nylon Ø 6mm	Nylon Ø 8mm	PTFE Outer Ø 4mm Inner Ø 2mm (1mm wall section)	Nylon Ø 6mm	Nylon Ø 8mm	PTFE Outer Ø 4mm Inner Ø 2mm (1mm wall section)
CDAS / OFAS / FBP HL 050 - HL 070	720mm (6 x)	825mm (1 x)	1000mm (1 x)	720mm (6 x)	350mm (1 x)	1200mm (1 x)
CDAS / OFAS / FBP HL 075 - HL 085	850mm (6 x)	970mm (1 x)	1000mm (1 x)	850mm (6 x)	570mm (1 x)	1200mm (1 x)

- **PTFE hygrometer piping, must be a single length of piping - no joins. Deviation may result in an incorrectly displayed dewpoint.**

Procedure - Dryers Manufactured Prior to 05/10/2021

- Cut new Ø 6mm & Ø 8mm piping based upon lengths shown in table above
- Make note of the piping identification number on each length of Ø 6mm piping and where each pipe is connected
- Ensure each length of new piping has a corresponding identification number
- At the 5/2 control valves - Disconnect the 6 x Ø 6mm pipes feeding the 2 x inlet cylinders and 1 x exhaust cylinder
- At the 5/2 control valve manifold block - Disconnect the Ø 8mm control air feed pipe
- Remove the 4 retaining screws attaching the backplate to the dryer
- Carefully rotate the backplate 180 degrees and re-attach the backplate to dryer using 2 of the existing retaining screws
- Connect new length of Ø 8mm pipe between the 5/2 manifold & dryer control air feed point on inlet casting
- Connect the new lengths of Ø 6mm piping to 5/2 control valves, ensuring the identification labels and piping configuration matches those used originally (see image).
- Replace Ø 4mm PTFE hygrometer piping with a longer, single length of Ø 4mm PTFE.

Procedure - Dryers Manufactured After 05/10/2021

- Cut new Ø 6mm & Ø 8mm piping based upon lengths shown in table above
- Make note of the piping identification number on each length of Ø 6mm piping and where each pipe is connected
- Ensure each length of new piping has a corresponding identification number
- At the 5/2 control valves - Disconnect the 6 x Ø 6mm pipes feeding the 2 x inlet cylinders and 1 x exhaust cylinder
- At the control air filter inlet - Disconnect the Ø 8mm control air feed pipe
- Remove the 4 retaining screws attaching the backplate to the dryer
- Carefully rotate the backplate 180 degrees and re-attach the backplate to dryer using 2 of the existing retaining screws
- Connect new length of Ø 8mm pipe between the control air filter inlet & dryer control air feed point on inlet casting
- Connect the new lengths of Ø 6mm piping to 5/2 control valves, ensuring the identification labels and piping configuration matches those used originally (see image).
- Replace Ø 4mm PTFE hygrometer piping with a longer, single length of Ø 4mm PTFE.

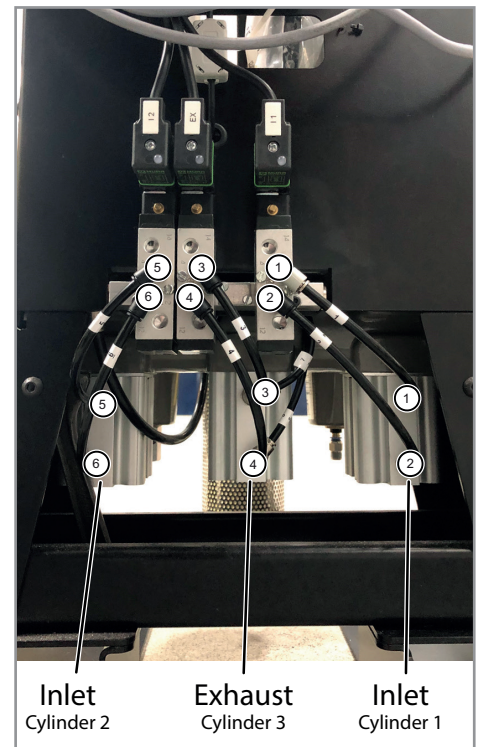

Standard Rear Panel
(Rear View)



Side Mounted Rear Panel
(Front View)



Side Mounted Rear Panel
(Side View)



Side Mounted Rear Panel
(Rear View)

Securing the Dryer

Mounting holes are provided in the feet of the dryer. Once the dryer has been positioned in its final location ensure that it is securely fixed in place using M15 fixing bolts.

Attach the Exhaust Silencer

The dryer is supplied with an exhaust silencer. If the dryer is to be located in a noise sensitive area, exhaust air can also be remotely piped away. If the exhaust is to be piped away then a minimum pipe size of 50mm (2 ins) should be used initially, expanding to larger diameter the longer the piping run becomes. As a rule of thumb a minimum bend radius of four times the radius of the pipe should be employed. Failure to pipe away correctly results in back pressure (indicated by a minimal pressure on the off-line pressure gauge) which prevents full regeneration of the off-line bed and results in loss of dewpoint.

Setting the Purge Air Volume

The volume of purge air required by the dryer must be set up during commissioning and is based upon the minimum pressure into the dryer during operation.

Purge Air Volume Setting Procedure

Before setting the purge air volume, fully close the Adjustable Purge Valve (ref 3 on diagram right) and ensure that the screwdriver slot is aligned with the number 12 on the purge dial.

Setting the purge air volume requires turning of the adjusting screw a number of full turns from fully closed, then fine tuning with partial turns to a numbered position on the dial.

Obtain the minimum operating pressure at the dryer inlet and use the table below to identify the number of full turns and partial turns required.



REF	DESCRIPTION
1	M15 fixing bolts (not supplied)
2	Exhaust Silencer
3	Adjustable Purge Dial

CDAS OFAS FBP	PURGE FLOW		DIAL SETTING	PRESSURE (Bar g)												
	(m³/hr)	(L/m)		4	5	6	7	8	9	10	11	12	13	14	15	16
HL 050	11	183	Full Turns	6	5	5	4	4	4	3	3	3	3	3	3	3
			+ Dial No.	6	10	1.5	8.5	4.5	1.5	11.5	9.5	7.5	5.5	4.5	3.5	2.5
HL 055	14	233	Full Turns	6	6	6	5	5	4	4	4	4	3	3	3	3
			+ Dial No.	11	7.5	1.5	7	2	10	6.5	4	1	11	9.5	8	7
HL 060	18	300	Full Turns	7	7	6	6	6	5	5	5	4	4	4	4	4
			+ Dial No.	4.5	0	9	6	2	8.5	4.5	0.5	9	6.5	4.5	2.5	1.5
HL 065	22	367	Full Turns	7	7	7	6	6	6	6	5	5	5	4	4	4
			+ Dial No.	8.5	4.5	1.5	10.5	8	5.5	2	9.5	5	2	11	8.5	7
HL 070	30	500	Full Turns	8	7	7	7	7	7	6	6	6	6	6	5	5
			+ Dial No.	4	11.5	8	5	2	0	10	8.5	7	5	1.5	10	8
HL 075	37	617	Full Turns	8	8	8	7	7	7	7	7	6	6	6	6	6
			+ Dial No.	9.5	4	0.5	9.5	7	4.5	3	1	11	9.5	8	7	5
HL 080	44	733	Full Turns	9	8	8	8	7	7	7	7	7	7	7	6	6
			+ Dial No.	3	9	4.5	1.5	10.5	8	6	4.5	3	1.5	0	10.5	9
HL 085	60	1000	Full Turns	10	9	9	8	8	8	8	7	7	7	7	7	7
			+ Dial No.	3	7	2	9	6	3	1	11	9	7.5	6.5	5	3.5

Important Note:

Failure to correctly set purge during commissioning will seriously affect dryer performance (outlet dewpoint & operational costs) and will invalidate warranty.

ELECTRICAL INSTALLATION



A fully qualified electrical engineer must undertake all field wiring and electrical work in accordance with local regulations.

During installation and commissioning, the controller must be connected to a suitable power supply and configured using the dip switches found on the main control board.

If using any of the additional functions, these should also be connected at this time.

Important Note: Some additional features also require activation using the DIL switches found on the main control board.

Dryer Electrical Supply

The dryer can be connected to an electrical supply in the range of 85V-265V / 1ph / 50Hz or 60Hz and should be connected in accordance with local wiring regulations.

Important Note:

The supplied ferrite (Part No. 74271222) must always be fitted to the incoming supply cable and as close as possible to the unit. Loop the cable next to the cable grommet and fit ferrite within the loop, covering two turns of the cable. (see drawing)

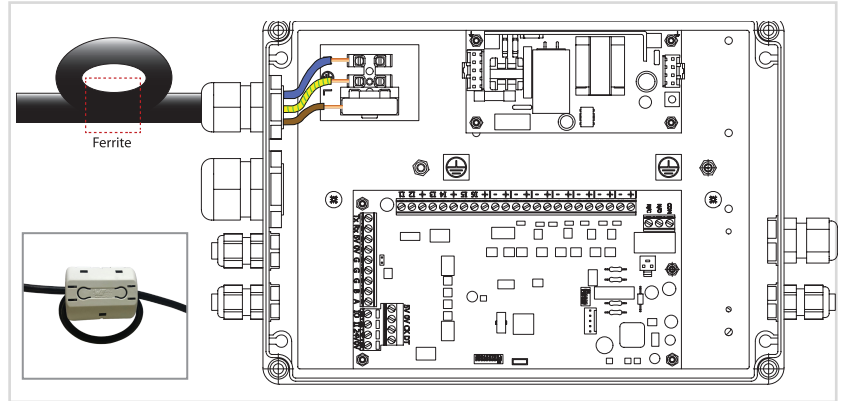

Commissioning – Controller Setup Basic Installation

Before operating the dryer, the following settings must be checked and if required be reconfigured to match the requirements of the installation:

Configure “Dewpoint setpoint”

- The control board must be set to the outlet dewpoint for which the dryer was sized.
- This setting will also configure the EST ‘ECO’ Set Point and Dewpoint Alarm Set Point.
- Factory Default Setting for -20°C/-40°C dryers is -40°C PDP. If a dryer is required to provide a -20°C outlet dewpoint, reconfigure Dipswitch Array 2, DIL Switch 5 & DIL Switch 6 as shown.
- Factory Default Setting for -70°C dryers is -70°C PDP.

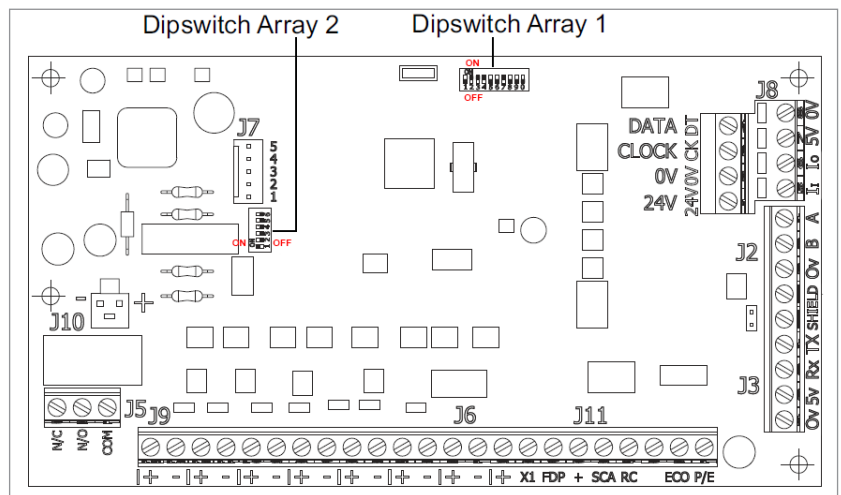

DIPSWITCH ARRAY (2)			
DIL SWITCH	FUNCTION	OFF	ON
5	Dewpoint Setpoint		
6		-20°C	-40°C

DEWPOINT SET POINT SELECTED	ECO SET POINT	DEWPOINT ALARM SET POINT
-20°C (-4°F)	-20°C (-4°F)	-5°C (+23°F)
-40°C (-40°F)	-40°C (-40°F)	-20°C (-4°F)
-70°C (-100°F)	-70°C (-100°F)	-56°C (-68°F)

Configure Inlet Valves Configuration (N/C - Normally Closed or N/O - Normally Open)

- Default Factory Setting is Normally Closed.
- If a dryer is required to operate in a Normally Open configuration, reconfigure Dipswitch Array 1, DIL Switch 7 as shown:

DIPSWITCH ARRAY (1)			
DIL SWITCH	FUNCTION	OFF	ON
7	Inlet Valves Normally Open (N/O) or Normally Closed (N/C)	N/O	N/C

Important Notes:

- Changing the configuration to Normally Open also requires a physical change to the inlet valve piping
- Swap Tubes 1 & 2 on Inlet Cylinder 1
- Swap Tubes 5 & 6 on Inlet Cylinder 2

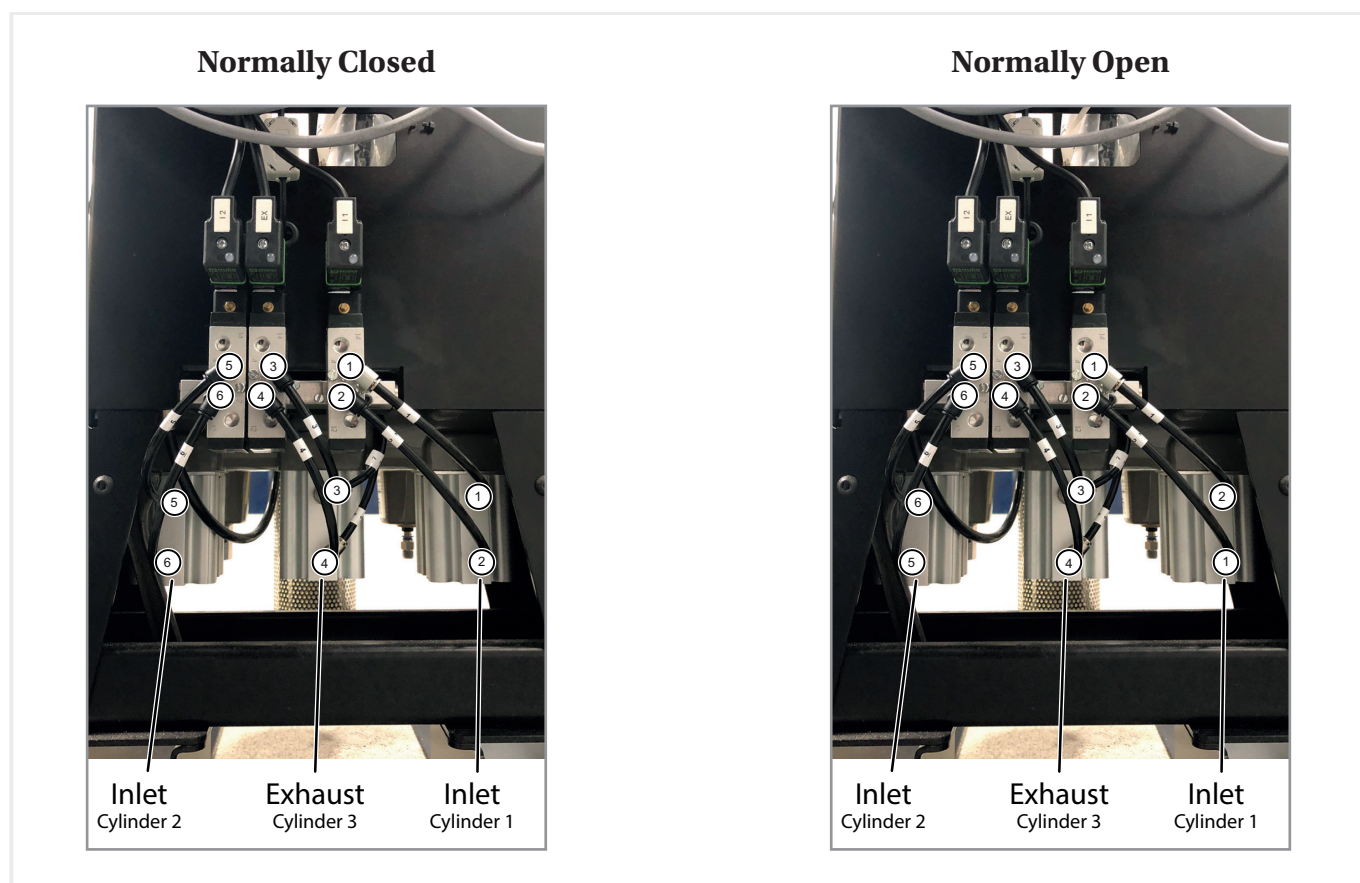

Configure Temperature Units to be displayed

- Default factory setting is °C. To show °F on the display, reconfigure Dipswitch Array 2, DIL Switch 3 as shown:

DIPSWITCH ARRAY (2)			
DIL SWITCH	FUNCTION	OFF	ON
3	Temperature Units	°C	°F

Commissioning – Controller Setup Advanced Installation

To access the additional functionality offered by the controller, the following settings must be activated and configured to match the requirements of the installation:

Remote Stop / Start (Refer to page 25)

- Dipswitch configuration required
- Physical connection to remote switch required

Purge Economy (Refer to page 26)

Important Note: Only possible if dryer is installed directly after the compressor (no wet air receiver)

- Physical connection to compressor required

Remote Alarm Connection (Refer to page 28)

- General Fault Relay Indicates Power Loss / Dewpoint Alarm / Sensor Fault
- Physical connection required

Dedicated dewpoint alarm (Refer to page 29)

- Requires additional alarm relay (not supplied)
- Physical connection required
- Activation in service software required

4-20mA Dewpoint Retransmission (Refer to page 30)

- Physical connection required
- Additional components required

MODBUS connectivity (Refer to page 32)

- Physical connection to remote system required
- Setup via service software may be required

CDAS HL / OFAS HL / FBP HL Dryer Auxiliary Connections

CDAS HL / OFAS HL / FBP HL dryers can be connected to external control and alarm circuits using the dedicated terminals on the lower terminal block of the PCB found inside the control box mounted at the rear of the dryer.

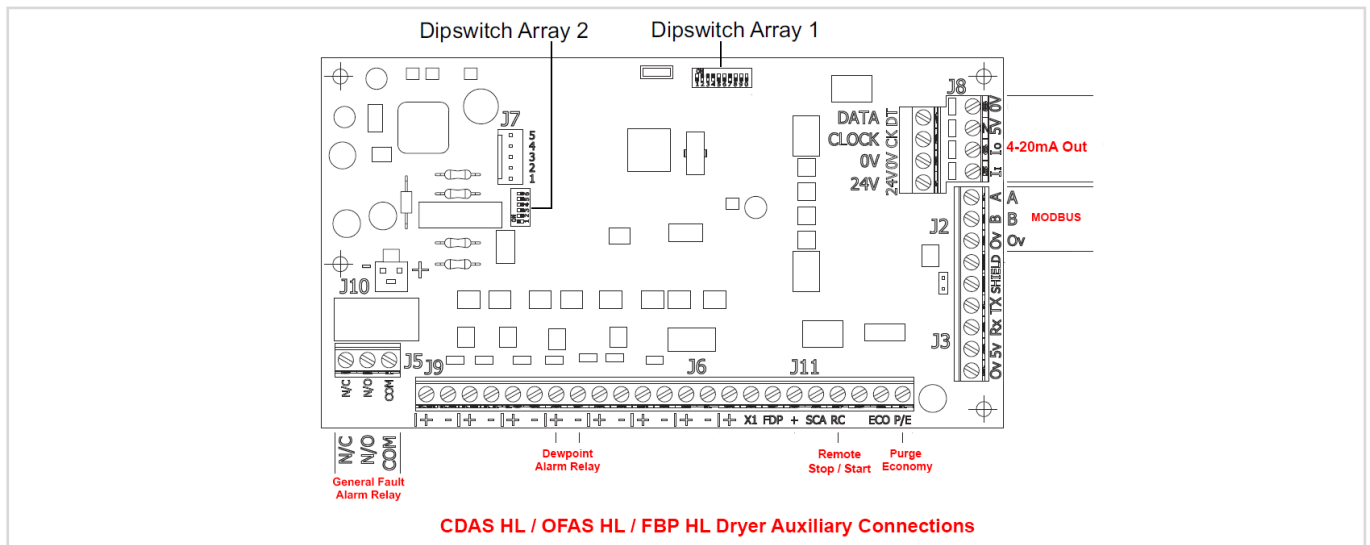

When making these connections it is recommended that:

1. Cable lengths do not exceed 30m in length.
2. Twisted screened cables (0.75mm²) are used for the remote start / stop, dewpoint retransmission and alarm relay connections.
3. Low voltage cables are routed away from high voltage supply cables

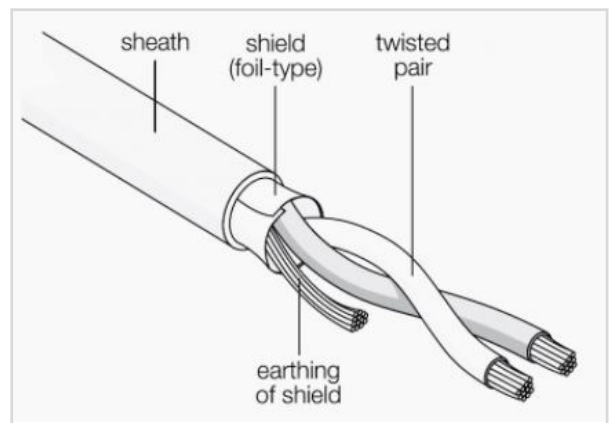

Remote Stop / Start Connection

CDAS HL / OFAS HL / FBP HL dryers can be configured to enable remote shut down and start up (Stop / Start) of the dryer. This requires a 24VDC signal to be supplied to the remote stop digital input (RC) on the control board and setting of DIL Switch 8 on Dipswitch Array 1 to enable

DIPSWITCH ARRAY (1)			
DIL SWITCH	FUNCTION	OFF	ON
8	Remote Stop / Start	Remote Stop Inhibited	Remote Stop Enabled

- The dryer control board supplies the 24V DC required to operate the Remote Stop / Start function.

Required for operation:

- An external remote switch (latching type).
- A 2 core twisted screened cable (0.75mm²), max length 30m.
- Connect one core of the screened cable from the "+" on the dryer control board to the remote switch via the screened cable.
- Connect the other core of the screened cable between the remote switch and the RC connection on the control board.

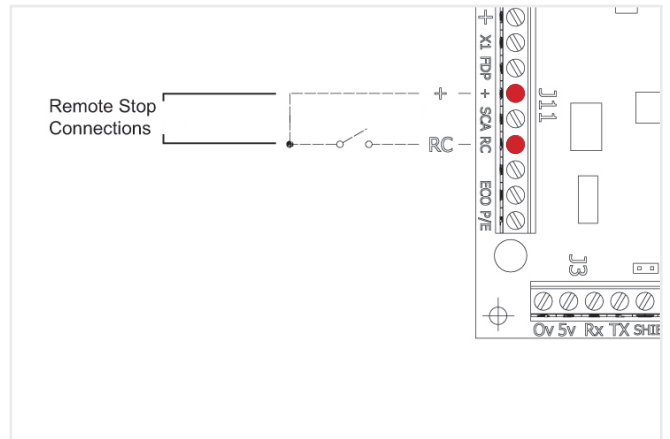

Remote Stop / Start Operation

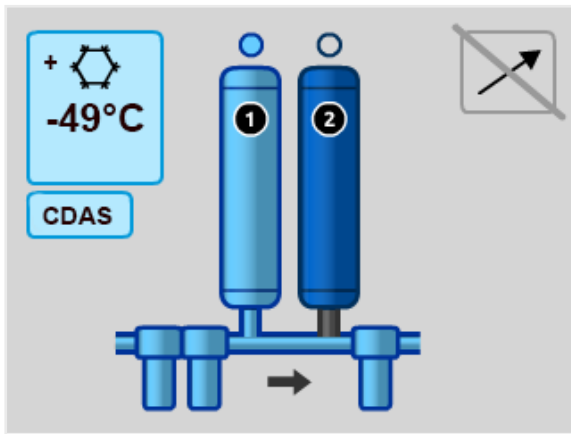

When remote stop / start has been connected and enabled using the DIL Switch 8 on Dipswitch Array 1, an icon will be shown on the display.

When the remote switch is open, the icon will have a grey background with a line through it and the dryer will operate normally.

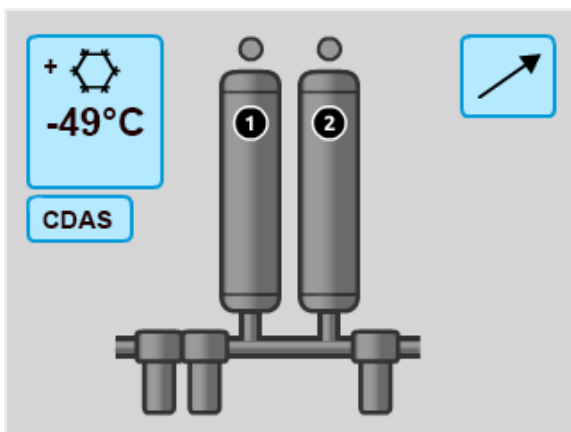

When the remote switch is closed, a 24V DC signal is applied to the digital input (RC).

The icon background will change from grey to blue and the line will disappear to indicate that the dryer has been remotely stopped.

The dryer will continue to cycle until the end of the current half cycle then stop.

The dryer will remain in this state until the remote switch is opened, where the controller will re-start the drying cycle on a fully regenerated desiccant bed.

When the dryer has been remotely "Stopped"

- The fault relay(s) will remain energised
- The icon on the display will change to indicate the dryer has been remotely stopped.
- Energy Saving modes "ECO" & "Purge Economy" are overridden

Important Notes:

- The default inlet valve configuration for CDAS HL / OFAS HL / FBP HL is Normally Closed (N/C).
- In this configuration, when the remote switch is closed and the ½ cycle is completed, the inlet and exhaust valve will be closed. There will be no air flow through the dryer, protecting the desiccant bed.

INLET VALVE CONFIGURATION	DEFAULT or OPTION	POWER LOSS	REMOTE STOP ACTIVATED	DESICCANT BED PROTECTED
Normally Closed (N/C)	Default	Inlet Valves Closed No compressed air flow through dryer	Inlet Valves Closed No compressed air flow through dryer	Yes
Normally Open (N/O)	Option	Inlet Valves Open Compressed air flow through dryer	Inlet Valves Open Compressed air flow through dryer	No

- The optional inlet valve configuration for CDAS HL / OFAS HL / FBP HL is Normally Open (N/O).
- If the dryer is configured for Normally Open operation, this will allow compressed air to flow through the dryer whilst the controller is powered off or not cycling from one column to another due to a remote stop being activated.
- Flowing compressed air through a non-cycling dryer will cause damage to the desiccant bed, invalidating warranty.
- Normally Open configuration is to be used at the user’s risk.

Purge Economy Connection

Purge economy can only operate if the dryer is installed directly after the compressor AND before an air receiver. Under no circumstances should purge economy be connected if there is an upstream, wet air receiver as this will saturate the desiccant bed, lose dewpoint and invalidate the dryer warranty.

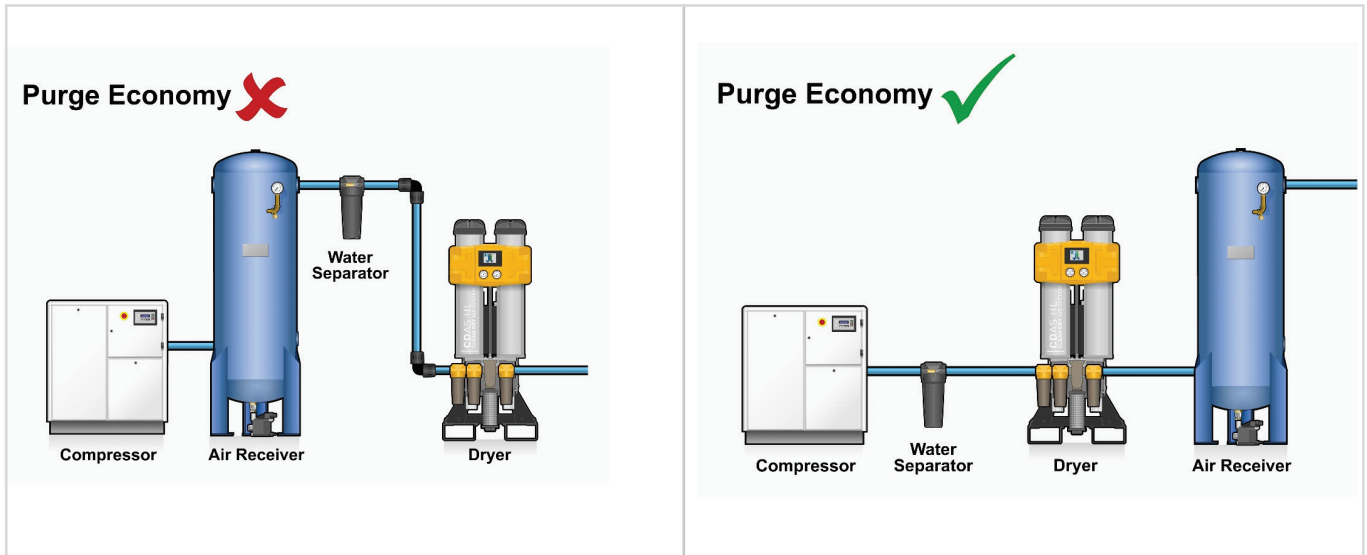

Purge economy requires a wired connection to the air compressor and relies on the compressor being fitted with a relay that will change state as the compressor switches between “on load” and “off load”.

At the Compressor

- Identify the On Load / Off Load Relay
- Determine which terminal connection on the relay is open when the compressor is on load and closes when the compressor is off load
- This terminal and the common terminal of the relay will be used to form a digital switch.
- A 2-core cable will be required between the compressor relay and the dryer.

At the Dryer

- The dryer control board supplies the 24V DC required to operate the Purge Economy Function.
- Connect one core of the cable from the “+” on the dryer control board to the connection on the relay that is closed when the compressor goes off load.
- Connect the other core of the wire between the common connection on the relay and the P/E connection on the control board.

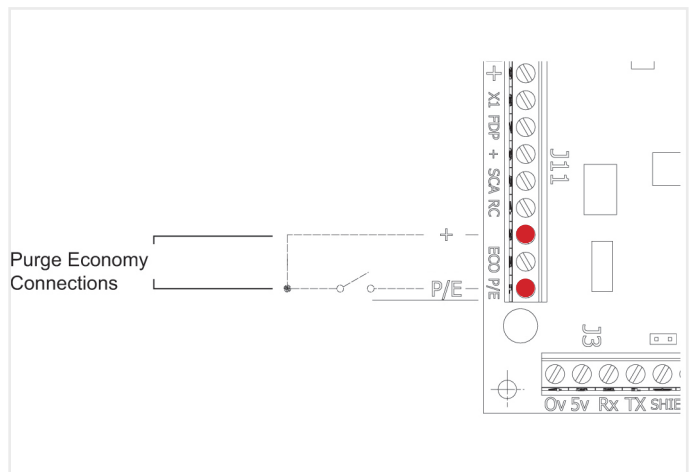

Purge Economy Operation

Compressor On Load

As the compressor is operating, the relay connection is open and the dryer will be operating normally, drying the compressed air.

Compressor Off Load

When the air compressor reaches its set operating pressure and goes off load, the relay in the compressor will close.

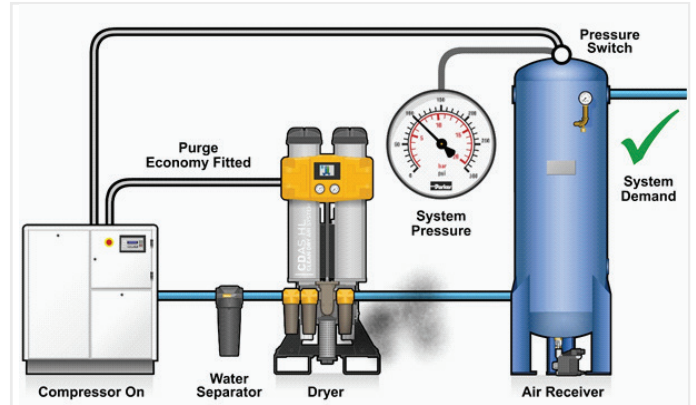

This completes the circuit, supplying 24VDC to the P/E (Purge Economy) terminal, activating the purge economy mode.

When purge economy is activated:

If the dryer purge economy mode has been set up as mode 1 (see page 40), the dryer continues until the end of the regeneration cycle, closes the exhaust valve then stops the cycle after repressurisation of the off-line column.

If the dryer purge economy mode has been set up as mode 2 (**default mode**), the dryer immediately closes the exhaust valve to repressurise the off-line column then stops the cycle.

With the exhaust valve closed, no purge air is consumed, saving energy & money.

The active inlet valve will remain energised (open). The fault relay(s) and spare output(s) will remain energised.



The purge economy icon will be visible on the display.

Once the system pressure drops due to air demand, the compressor re-starts.

The compressor relay contact will open, removing the 24V DC from the Purge Economy terminal.

The normal drying cycle will now be resumed.

Remote Alarm Connection – General Fault Alarm

The CDAS HL / OFAS HL / FBP HL dryer controller includes a general fault alarm used to indicate power loss, dewpoint alarm or dewpoint sensor failure.

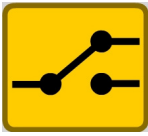

When the general fault alarm is active, an icon will be visible on the display.

The general fault alarm is linked to a relay providing volt free contacts: Normally Closed (N/C), Normally Open (N/O), and a Common (Com)

These contacts are rated 24Vdc and 230Vac @ 1A and can be used for remote alarm indication. The user can select to use either N/C & Com or N/O & Com to create a circuit should an alarm event occur.

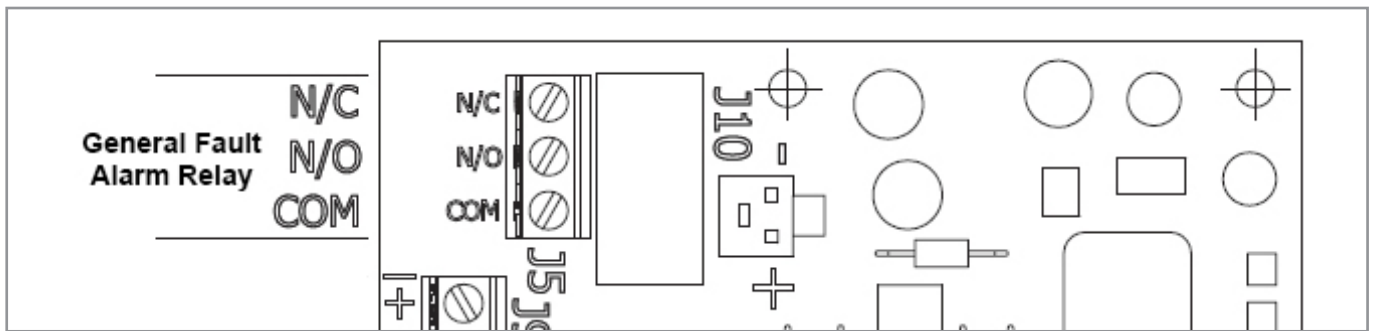

Remote Alarm Connection Operation

Upon the application of power to the dryer and under normal dryer operation, the general fault alarm relay will be energised, changing the states of the N/C & N/O contacts.

POWER ON / NO ALARM
N/C & Com – Open Circuit
N/O & Com – Closed Circuit

Should the dewpoint alarm be activated, a dewpoint sensor fault be detected, or a power loss occur, the relay will de-energise, changing the state of the N/C & N/O contacts.

POWER LOSS / ALARM ACTIVATED
N/C & Com – Closed Circuit
N/O & Com – Open Circuit

Remote Alarm Connection - Dedicated Dewpoint Alarm

The CDAS HL / OFAS HL / FBP HL dryer controller includes the ability to connect a dedicated dewpoint alarm relay that will activate only if a dewpoint alarm occurs. This function requires the connection of an additional relay (not supplied) and activation by a trained engineer using the ADS service software.

Once activated via the ADS service software, the dewpoint alarm functionality is removed from the generic fault relay and assigned to the dedicated dewpoint alarm output.

The connection to the control board is used to energise the additional alarm relay (not supplied) and is rated at 3-30W@24VDC

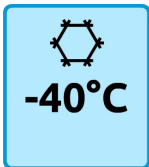
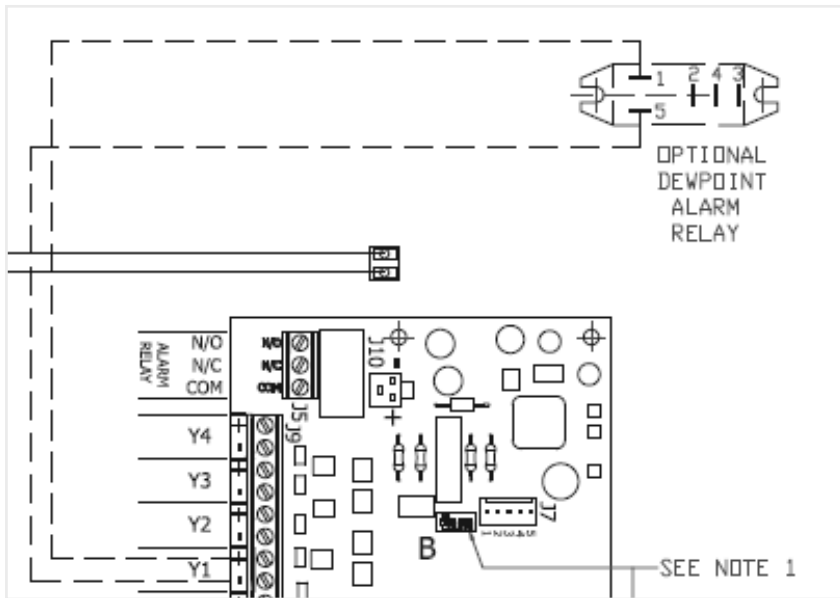

On the display screen, a blue box and background around the dewpoint icon and outlet dewpoint value indicates when the dryer is operating within normal parameters and delivering a dewpoint less than or equal to the dewpoint setpoint.



Should the outlet dewpoint of the dryer be higher than the dewpoint setpoint, a dewpoint alarm is activated.

This is identified by the normally blue background around the dewpoint icon changing to a yellow background.

With the dedicated dewpoint alarm relay fitted and enabled, the general fault alarm relay icon will not be shown.

The dedicated dewpoint alarm relay will change state (de-energised), the general fault alarm relay will not change state (it will remain energised).

4-20mA Dewpoint Retransmission

The CDAS HL / OFAS HL / FBP HL dryer controller includes a 4-20mA analogue output which is used for the retransmission of the dryer dewpoint. Recommended cable: 0.75mm² twisted screened cable not exceeding 30m in length.

The type of dewpoint sensor fitted differs depending upon the dryer range and outlet dewpoint. The table below highlights the sensors used.

DRYER MODEL	PRESSURE DEWPOINT	
	-20°C / -40°C (-4°F / -40°F)	-70°C (-100°F)
CDAS HL	Parker Dewpoint Sensor (PDS)	Hygrometer
OFAS HL	Parker Dewpoint Sensor (PDS)	Hygrometer
FBP HL	Hygrometer	Hygrometer

DEWPOINT SENSOR TYPE	PRESSURE DEWPOINT MEASUREMENT RANGE	ACCURACY	CHANGE SENSOR EVERY
Parker Dewpoint Sensor (PDS)	-50°C to +0°C PDP	+/- 4°C	12 Months
Hygrometer	-100°C to +20°C PDP	+/- 2°C	12 Months

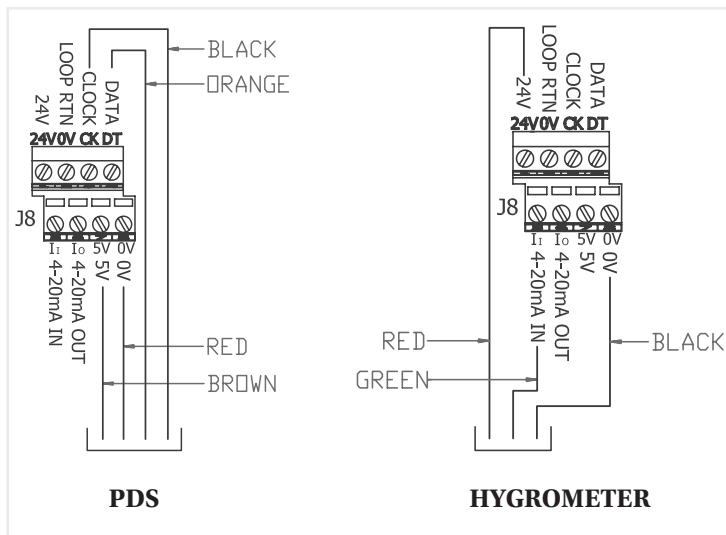

The Parker Dewpoint Sensor (PDS) and Hygrometer differ in how they are wired to the CDAS HL / OFAS HL / FBP HL controller PCB.

Connection of the 4-20mA retransmission is identical for both the Parker Dewpoint Sensor (PDS) and Hygrometer.

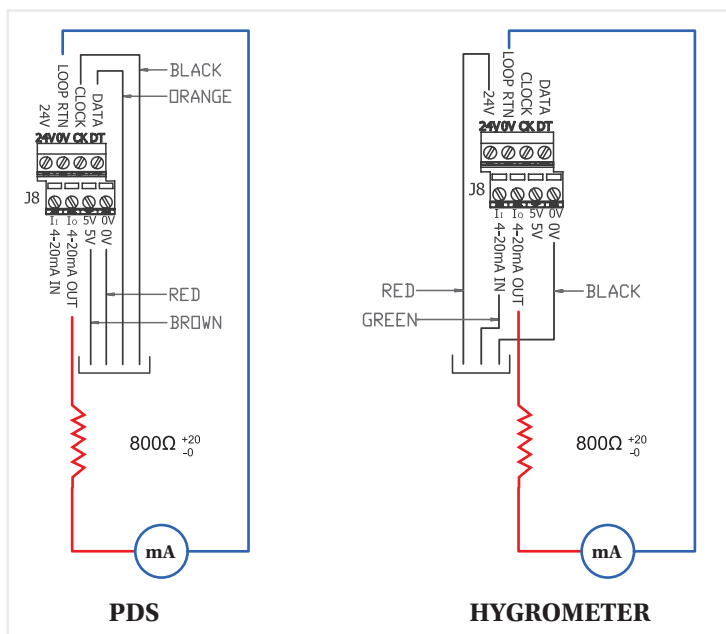

An 800Ω (+20 Ω / -0 Ω) resistor will be required in series in the loop circuit.

Using the 4-20mA Signal

The calculation used to interpret the 4-20mA signal differs between the Parker Dewpoint Sensor (PDS) and Hygrometer.

Parker Dewpoint Sensor 4-20 mA output Dewpoint Calculation

PARKER DEWPOINT SENSOR																				
Current mA	4	5	6	7	8	9	10	10.66	11	12	13	14	15	16	17	17.4	18	19	20	
PDP °C	Out of Sensor Accuracy Range							-50	-48	-40	-33	-25	-18	-10	-3	0	Out of Sensor Accuracy Range			

$$Dewpoint = \left(\left(\frac{mA}{4} - 1 \right) \times 30 \right) - 100$$

example:
measured value = 12mA

$$\left(\left(\frac{12}{4} - 1 \right) \times 30 \right) - 100 = -40$$

measure value = 14mA

$$\left(\left(\frac{14}{4} - 1 \right) \times 30 \right) - 100 = -25$$

It should be noted that the accuracy of measured mA reflects the accuracy of the Parker Dew Point Sensor ±4°C.

Hygrometer 4-20 mA output Dewpoint Calculation

PARKER DEWPOINT SENSOR																			
Current mA	4	5	6	7	8	9	10	11	12	13	14	15	16	17	18	19	20		
PDP °C	-100	-93	-85	-78	-70	-63	-55	-48	-40	-33	-25	-18	-10	-3	5	13	20		

$$Dewpoint = ((mA - 4) \times 7.5) - 100$$

example:
measured value = 12mA

$$((12 - 4) \times 7.5) - 100 = -40$$

measure value = 14mA

$$((14 - 4) \times 7.5) - 100 = -25$$

MODBUS connectivity

The CDAS HL / OFAS HL / FBP HL dryer controller includes an RS485 port for MODBUS communication with a remote system using the MODBUS RTU protocol. All connections should be made to the 3 terminal block connections as shown below.

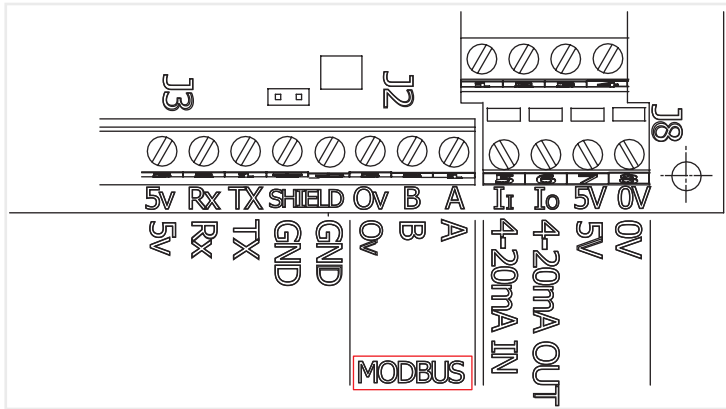

Recommended Cable Size / Length

TWISTED PAIR SCREENED CABLE RECOMMENDED CABLE SIZE	MAX RECOMMENDED CABLE LENGTH
0.5mm ² - 0.75mm ²	500m [1650 ft]
0.75mm ² - 1.0mm ²	1000m [3300 ft]

The cable screen should be terminated at the terminal marked 0V. It is suggested that only the controller end of the screen is connected to earth.

Default MODBUS Settings

Each unit (master & slaves) on the MODBUS network must have matching communication settings and a unique unit identification (ID). The default settings for the CDAS HL / OFAS HL / FBP HL controller are shown below.

TWISTED PAIR SCREENED CABLE RECOMMENDED CABLE SIZE	
Baud Rate	19200
Number of Data Bits	8
Parity	Even
Number of Stop Bits	1
Modbus Unit ID (Node)	55

The parameters for baud rate, data bits, parity, stop bits and unit ID can all be changed by a trained service engineer using the Parker ADS service software.



- When connected, the MODBUS icon will be shown on the display
- This also includes the MODBUS Unit ID (Node) number (default ID of 55 shown)

MODBUS Strings

HOLDING NUMBER REGISTER	HOLDING REGISTER DESCRIPTION FUNCTION CODE 1	DETAILS
0		
1	Dewpoint Alarm	0: Reset 1: Active
2		
3	Inlet A	0: De-energised 1: Energised
4	Inlet B	0: De-energised 1: Energised
5	Exhaust	0: De-energised 1: Energised
6		
7		
8	Fault relay	0: De-energised (Alarm) 1: Energised
9		

HOLDING NUMBER REGISTER	HOLDING REGISTER DESCRIPTION FUNCTION CODE2	DETAILS
0	External Input: Purge Economy	0: De-asserted 1: Asserted
1	External Input: ECO	0: De-asserted 1: Asserted
2	External Input: Remote Stop	0: De-asserted 1: Asserted
3	External Input: SCA	0: De-asserted 1: Asserted
4	External Input: Filter DP High	0: De-asserted 1: Asserted
5	Unused	
6	DIP1-1: Service Timer Carbon	0: Reset 1: Active
7	DIP1-2: Service Timer Filter	0: Reset 1: Active
8	DIP1-3: Service Timer Desiccant	0: Reset 1: Active
9	DIP1-4: Cycle 1 (6 minute) Select	0: Reset 1: Active
10	DIP1-5: Cycle 2 (4 minute) Select	0: Reset 1: Active
11	DIP1-6: Cycle 3 (Custom) Select	0: Reset 1: Active
12	DIP1-7: Inlet Valve Configuration (on Remote Stop)	0: Energised 1: De-energised
13	DIP1-8: Remote Stop Enable	0: Disabled 1: Enabled
14	DIP1-9: Purge Setting Mode	0: Disabled 1: Enabled
15	DIP1-10: Service Timer FBP	0: Reset 1: Active
16	DIP2-1: Dewpoint Sensor Enable	0: Disabled 1: Enabled
17	DIP2-2: Dewpoint Sensor Select	0: I2C Sensor 1: 4-20mA Sensor
18	DIP2-3: Temperature Units	0: Deg C 1: Deg F
19	DIP2-4: Moisture Override Enable	0: Disabled 1: Enabled
20	DIP2-5: ECO Setpoint 1	0: -40 C 1: -20 C
21	DIP2-6: ECO Setpoint 2	0: Custom 1: -70 C

MODBUS Strings Continued..

HOLDING NUMBER REGISTER	HOLDING REGISTER DESCRIPTION FUNCTION CODE 3	DETAILS
0	Software Version	
1	Graphics Version	
2	Run Time (Seconds)	
3		
4	ECO(DDS) Time (Seconds)	
5		
6	Calculated ECO(DDS) %	
7		
8	Display connection Status	0: Not Connected 1: Connected
9	Dew Point	
10	System Status 1	Bit 0: Dewpoint Alarm Bit 1: Dewpoint Sensor Open Circuit Bit 2: Dewpoint Sensor Short Circuit Bit 3: Not Defined Bit 4: Not Defined Bit 5: Not Defined Bit 6: Not Defined Bit 7: Carbon Hours Warning Bit 8: Filter Hours Warning Bit 9: Desiccant Hours Warning Bit10: Catalyst Hours Warning Bit 11: Carbon Hours Alarm Bit 12: Filter Hours Alarm Bit 13: Desiccant Hours Alarm Bit 14: Catalyst Hours Alarm Bit 15: Invalid DIP Switch Settings
11	System Status 2	Bit 0: Remote Stop Mode Active Bit 1: Purge Economy Mode Active Bit 2: Purge Setting Mode Active Bit 3: Filter DP Alarm Active Bit 4: SCA Alarm Active Bit 5: Unused Bit 6: Dewpoint Sensor Fault Bit 7: I2C Sensor Fault Bit 8: I2C Magic Number Fault Bit 9: I2C Sensor Overrange Fault Bit10: BAS Mode Active Bit 11: BAS Mode Config Fault Bit 12: Unused Bit 13: Unused Bit 14: Unused Bit 15: Unused
12	ADS Config: Hygrometer Minimum Output	Range: -120C to +40C
13	ADS Config: Hygrometer Range	Range: 50 to 150
14	ADS Config: Startup Dewpoint Alarm Delay	Range: 0 to 240 minutes
15	ADS Config: Dewpoint Fault Time Delay Minutes	Range: 0 to 60 minutes
16	ADS Config: Custom Dewpoint Alarm offset	Range: -120C to + 120C
17	ADS Config: Moisture Override Period	Range: 0 to 240 minutes
18	ADS Config: Moisture Override Half Cycles	Range: 0 to 10

HOLDING NUMBER REGISTER	HOLDING REGISTER DESCRIPTION FUNCTION CODE 3	DETAILS
19	ADS Config: Custom EST Setpoint	Range: -120C to 0C
20	ADS Config: Service Interval (Filter)	500 to 30,000Hours
21	ADS Config: Inlets N/O On Standby	0: Off 1: On
22	ADS Config: Separate Dewpoint Alarm Output	0: Off 1: On
23	ADS Config: Selected Cycle	0: 6 mins 1: 4 mins 2: Custom
24	ADS Config: Moisture Override Cycle Number	0: Disabled >0 Active (No. MO Cycles)
25		
26	IADS Config: IST Sensor Bias	
27	ADS Config: MODBUS Baud Rate	Range: 9600, 19200 or 38400 Baud
28	ADS Config: MODBUS Parity	Range: 0 (None), 1 (Odd), 2 (Even)
29	ADS Config: MODBUS Stop Bits	Range: 1 or 2
30	ADS Config: Custom Cycle Side A Exhaust On Time	Range: 0 to 1800s
31	ADS Config: Custom Cycle Side A Off Time	Range: 0 to 1800s
32	ADS Config: Custom Cycle Side A Exhaust Off Time	Range: 0 to 1800s
33	ADS Config: Custom Cycle Side B Exhaust On Time	Range: 0 to 1800s
34	ADS Config: Custom Cycle Side B Off Time	Range: 0 to 1800s
35	ADS Config: Custom Cycle Side B Exhaust Off Time	Range: 0 to 255
36	ADS Config: Modbus Address	Range: 0 to 255

Changing MODBUS communication Settings Via ADS Service Software

Important Note:

After changing any parameters, the control board must be power cycled (Power off / Power On) for the changes to be accepted.

To change the baud rate on the CDAS HL /OFAS HL / FBP HL dryers it is necessary to connect the dryer to a PC using the Parker ADS service software to communicate with the control board.

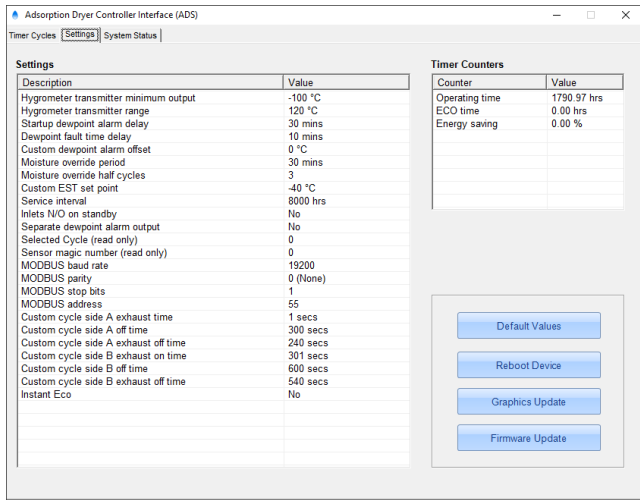

Once the dryer is connected and the ADS software started, navigate to the SETTINGS tab.

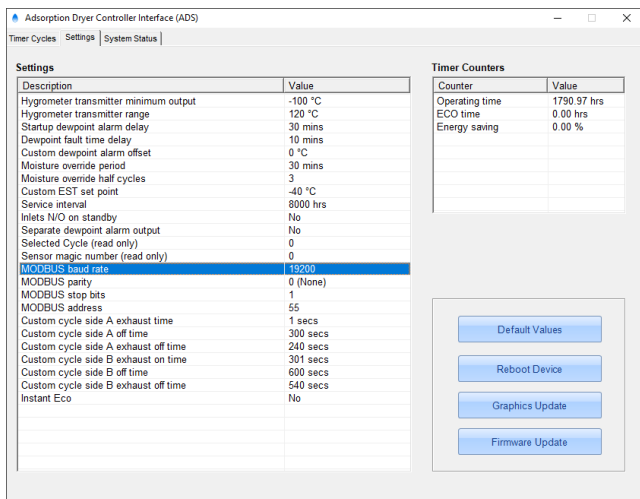

Left click on 'MODBUS baud rate.'

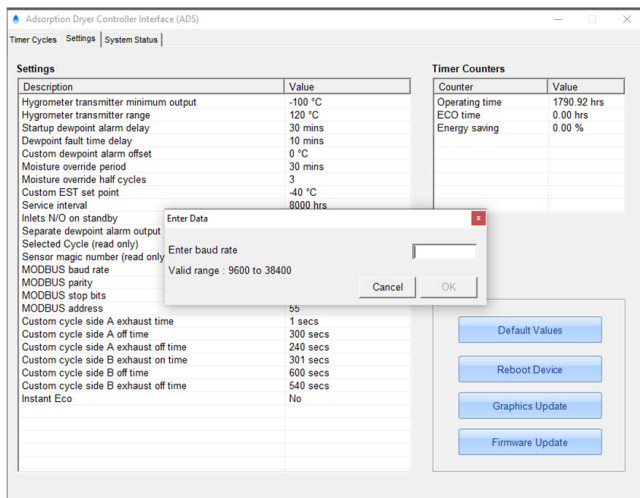

This will open a second window which will allow you to change the baud rate to match that of the MODBUS system.

The settings for MODBUS Parity, MODBUS Stop Bits and MODBUS Address (Unit ID or Node) are selected and changed in the same way to match the MODBUS system parameters.

**CDAS HL
OFAS HL
FBP HL
OPERATION**

OVERVIEW OF OPERATION

CDAS HL / OFAS HL / FBP HL purification systems are based around a heatless adsorption dryer and associated pre filtration and post filtration.

Adsorption dryers are designed for the treatment of water vapour only and therefore require pre-treatment of the incoming compressed air to operate correctly and protect the adsorbent desiccant bed. CDAS HL / OFAS HL / FBP HL pre filtration consists of a general purpose coalescing filter and a high efficiency coalescing filter for the treatment of solid contaminants (atmospheric particulate, rust, pipe-scale, micro-organisms) and aerosols (oil and water). Should liquid water or liquid oil be present at the inlet of the CDAS HL / OFAS HL / FBP HL, a liquid separator (OIL-X Grade WS) will also be required to protect the pre filtration.

The heatless adsorption dryer of CDAS HL / OFAS HL / FBP HL operates on the Pressure Swing Adsorption (PSA) principle and consists of two identical drying columns (referred to as Column 1 & Column 2). Each column contains cartridges filled with adsorbent (desiccant) material.

During operation, one column will be used to dry the incoming process air, whilst the opposite column is being regenerated and readied for use. Heatless adsorption dryers use a small proportion of the dry process air known as purge air to regenerate the desiccant material. Purge air is expanded to atmospheric pressure (where it becomes even drier) and is passed over the off-line desiccant bed where it strips the moisture from the desiccant material. The columns will be swapped periodically (referred to as "changeover") to ensure a constant supply of dry air is always available downstream.

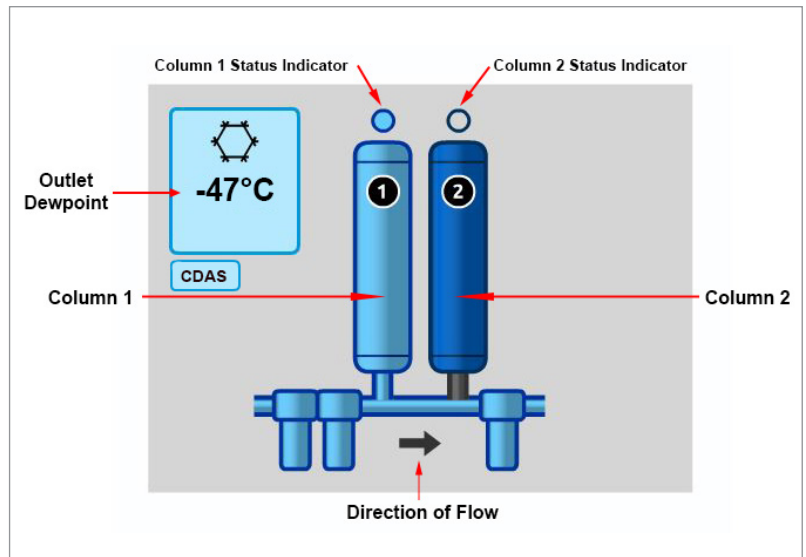

Once the compressed air is dried, the air flow path and final treatment differs between CDAS HL / OFAS HL / FBP HL.

CDAS HL

Once dried, the process air is passed through a general purpose dry particulate filter before exiting the unit.

OFAS HL / FBP HL – Column 3

OFAS HL and FBP HL models also include an additional column (referred to as Column 3). After drying, compressed air is passed through column 3 which contains an activated carbon cartridge for the reduction of oil vapour.

OFAS HL

Upon exiting Column 3, the compressed air is passed through a single general purpose dry particulate filter before exiting the unit.

FBP HL

Upon exiting Column 3, the compressed air is passed through a pair of dry particulate filters (general purpose and high efficiency) before exiting the unit.

Important Notes:

Different beds of desiccant material are used within each dryer, depending upon the outlet dewpoint required.

Two variants are available to cover three outlet dewpoints of $\leq -20^{\circ}\text{C}$, $\leq -40^{\circ}\text{C}$ and $\leq -70^{\circ}\text{C}$.

CDAS HL / OFAS HL / FBP HL OUTLET DEWPOINT	DESICCANT MATERIAL USED
$\leq -20^{\circ}\text{C}$ / $\leq -40^{\circ}\text{C}$	100% Activated Alumina
$\leq -70^{\circ}\text{C}$	20% Silica Gel / 80% Molecular Sieve

Important Notes:

- CDAS HL / OFAS HL / FBP HL dryer models must be ordered to match the required outlet dewpoint of the site.
- CDAS HL / OFAS HL / FBP HL utilise cartridges that are pre-filled with the correct grade and quantity of desiccant material (forming the split beds highlighted above).
- CDAS HL / OFAS HL / FBP HL 60 month service kits are therefore specific to the outlet dewpoint of the dryer.

CDAS HL / OFAS HL / FBP HL OPERATION

CDAS HL / OFAS HL / FBP HL Dryer Cycle Times and Operation

CDAS HL / OFAS HL / FBP HL dryers are designed to use two drying columns to deliver a constant outlet dewpoint.

A full cycle is the time it takes the dryer to fully utilise the desiccant material in both columns. A full cycle on CDAS HL / OFAS HL / FBP HL dryers operating at full load = 360 Seconds (6 minutes).

A ½ cycle is the time it takes the dryer to fully utilise the desiccant material of a single column. A ½ cycle on CDAS HL / OFAS HL / FBP HL dryers operating at full load = 180 Seconds (3 minutes).

Drying of the Compressed Air (3 Minutes on Fixed Timing Cycle)

Having passed through the coalescing pre filters, the inlet valves direct the incoming process air through one of the two dryer columns containing the desiccant cartridges (column 1 in the example image).

When a column is drying compressed air, it is referred to as the 'on-line' column.

Compressed air enters the desiccant cartridge of the on-line column at the bottom and flows upwards where it is in contact with the bed of adsorbent desiccant material. Water vapour in the compressed air is adsorbed by the desiccant material.

Standard drying cycle (no EST) is 180 seconds.

As the dried compressed air reaches the top of the desiccant cartridge, it changes direction, flowing down the column around the desiccant cartridge and into the outlet dry particulate filter (CDAS) or into the inlet of Column 3 (OFAS HL and FBP HL).

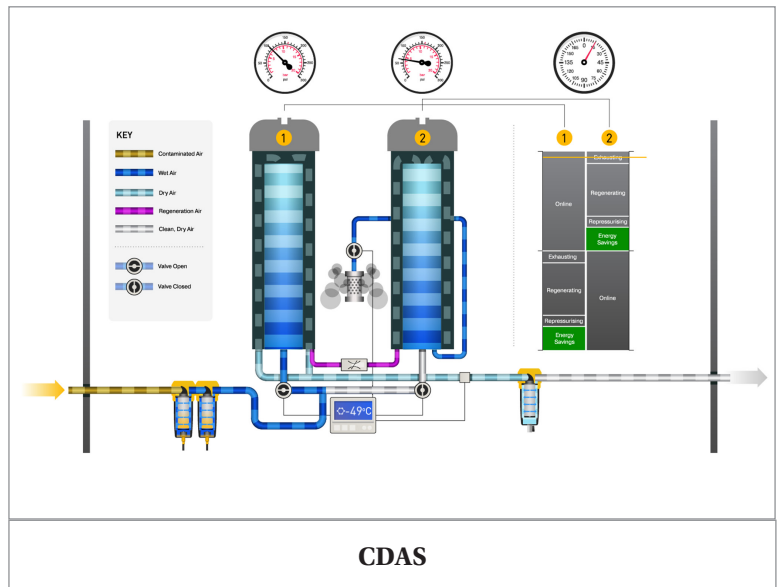

Regeneration of the Off-line Desiccant Material

Exhausting or De-pressurisation

At the same time compressed air is directed through the on-line column to be dried, the opposite column (column 2 in the image) will be undergoing regeneration (referred to as the "off-line" column). To regenerate the off-line column, the pressurised compressed air it contains must first be vented to atmosphere. To do this the dryer controller will open the exhaust valve, allowing the compressed air contained within the off-line column to exit via the exhaust valve and silencer. This process of exhausting the air is known as de-pressurisation. A check valve (ball) prevents the process air from flowing down the off-line column.

Regeneration (2 ½ Minutes)

Once the off-line column has been de-pressurised, the exhaust valve will remain open for the regeneration cycle. Expanded, dry purge air taken from the process air will flow up the outside of the desiccant cartridge to the top of the column then down the inside of the cartridge, across the adsorbent desiccant bed for 150 seconds (2 ½ minutes), stripping the moisture from the desiccant material as it flows out of the dryer via the open exhaust valve and silencer.

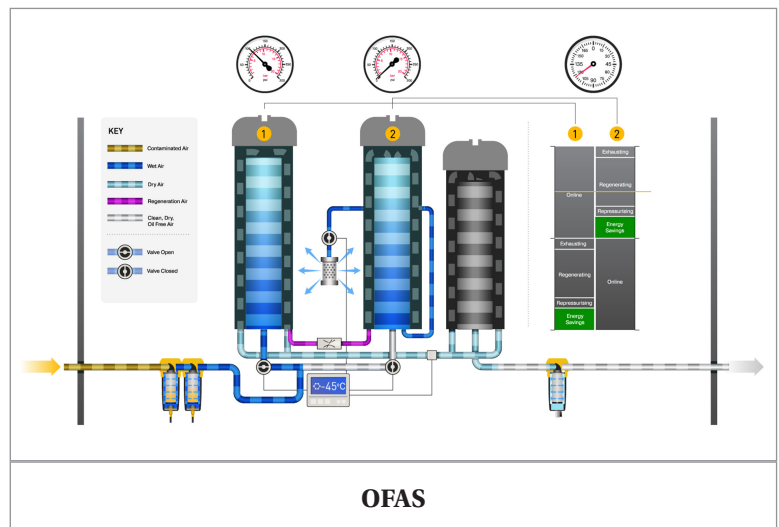

Important Note: Purge air volume must be set up during commission to supply the correct amount of purge air required for efficient regeneration. Refer to page 21 for purge volume setting.

Re-pressurisation (30 seconds)

After 150 seconds (2 ½ minutes) of regeneration, the exhaust valve will close, and the purge air will re-pressurise the off-line column. This is to ensure there is no drop in downstream pressure as the drying columns change over. Repressurisation time is 30 seconds.

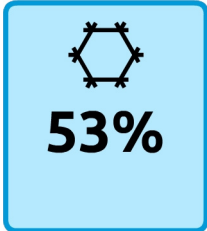

At column changeover, the dewpoint display on the screen will change to show the total overall energy savings as a percentage. This total will be visible for 4 seconds at the beginning of each ½ cycle. The energy saving percentage is calculated from initial start-up of the dryer

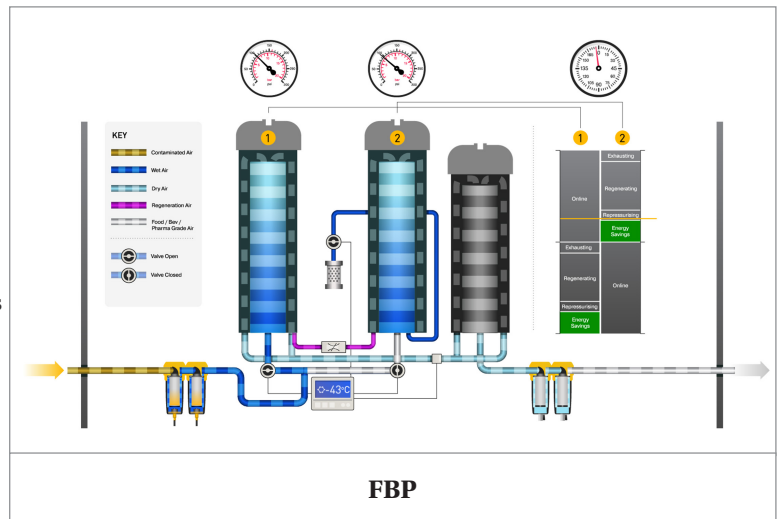

Changeover (Fixed Timing Cycle)

Following re-pressurisation, the controller will instruct the dryer to “changeover”. On a fixed timing cycle, drying & regeneration is 180 seconds (3 minutes). Using the inlet valves, the process air flow will be redirected over to the newly regenerated desiccant bed, allowing the wet adsorbent material of the opposite column to be regenerated.

CDAS HL / OFAS HL / FBP HL Dryer Timing Cycles

All adsorption dryers have a standard fixed cycle to ensure drying / regeneration / changeover is continuous. The diagram below illustrates the fixed timing cycle of a CDAS HL / OFAS HL / FBP HL dryer.

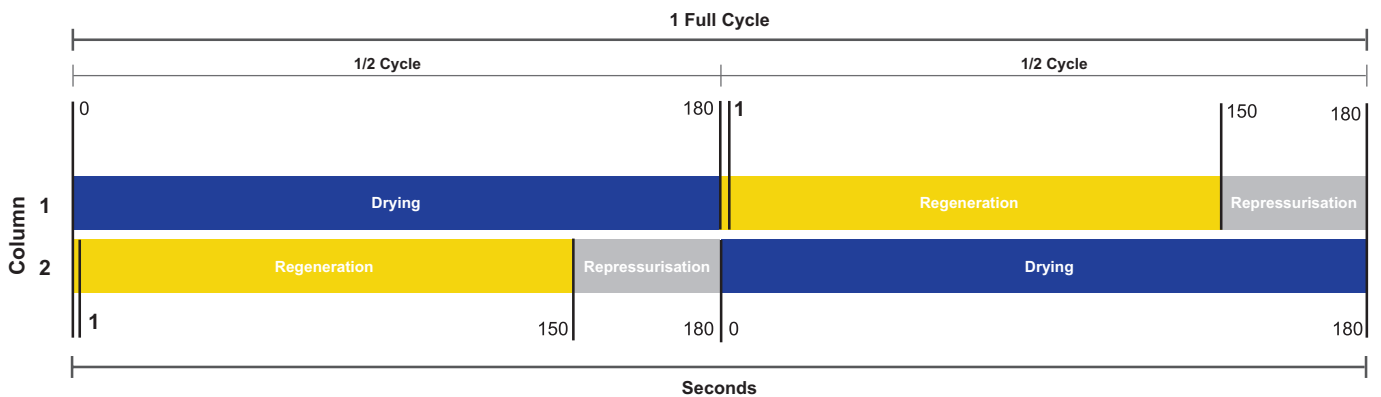

1 Full Cycle = 360 Seconds (6 minutes)

½ Cycle = 180 Seconds (3 minutes)

CDAS HL / OFAS HL / FBP HL Energy Saving Technologies

To provide a consistent outlet dewpoint, the desiccant bed of an adsorption air dryer must be “sized” to match the maximum water vapour loading of the site and ensure that the adsorption bed is large enough to deliver a consistent outlet dewpoint based upon the fixed timing cycle.

The energy consumed by a heatless adsorption dryer comes from generation of the process air used as purge air to regenerate the off-line desiccant bed.

In periods of low demand and or in winter, when the water vapour loading of the incoming compressed air can be reduced, operating on a fixed timing cycle will consume more energy than is required. To significantly reduce this energy loss, each CDAS HL / OFAS HL / FBP HL dryer is fitted with two energy saving functions as standard, called EST & Purge Economy.

EST – Energy Saving Technology (Also known as DDS or Dewpoint Dependent Switching)

Each CDAS HL / OFAS HL / FBP HL dryer includes an electronic control system with colour display, providing a visual indication of the unit's performance. Linked to this control system is a dewpoint sensor which constantly monitors the outlet dewpoint and adjusts the regenerating cycle to exactly match the incoming water vapour loading of the dryer.

EST Operation

At the end of the regeneration cycle and prior to column changeover, the exhaust valve is closed to allow the purge air to re-pressurise the off-line column. After re-pressurisation, both drying chambers will be at full line pressure, no purge air is being used for regeneration and the dryer is in a state of zero energy consumption.

With a fixed timing cycle, the drying chambers would now proceed to change over automatically, however with EST, the controller will use the included dewpoint sensor to check the outlet dewpoint of the dryer. If the compressed air dewpoint is lower than the ECO setpoint (the dewpoint for which the dryer was selected to deliver), the desiccant material is only partially saturated and has drying capacity remaining within it.

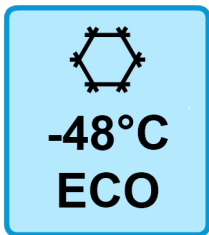

The EST energy saving technology will therefore override the standard timing cycle and the dryer will continue to dry on the same column with zero energy consumption for regeneration. During this period, "ECO" will be displayed on the controller screen underneath the outlet dewpoint value.

The dewpoint sensor constantly monitors the outlet pressure dewpoint until the eco setpoint is reached, at which point column changeover will occur.

The drying and regenerating cycle will then continue normally until the next column changeover when the EST energy saving technology may again extend the drying cycle as dictated by the outlet pressure dewpoint.

During the extension of the drying cycle, no purge air is consumed, saving compressed air, energy and money.

The diagram below illustrates the EST timing cycle of a CDAS HL / OFAS HL / FBP HL operating at variable inlet conditions (EST 'ECO' active, Moisture Override Not Activated).

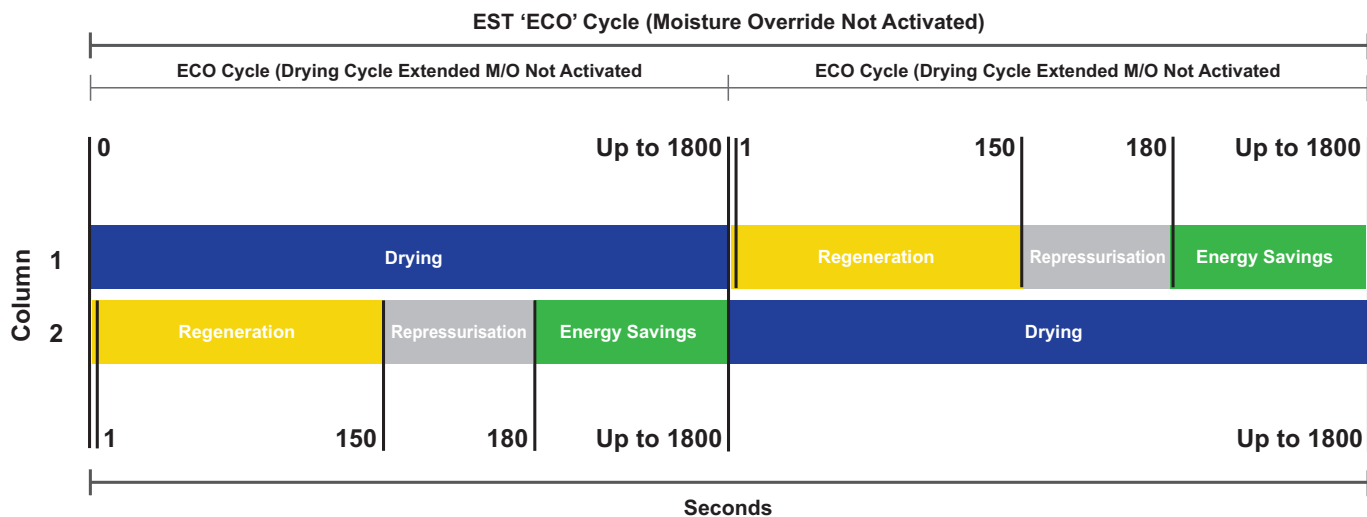

Important Notes:

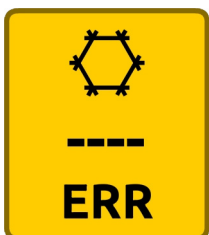

Should an error occur with either the Parker Dewpoint Sensor (PDS) or the Dewpoint Hygrometer, a yellow box will appear around the dewpoint icon. The outlet dewpoint figure will be replaced with "---" and "ERR" will be displayed.

The dryer will revert to a fixed 3 minute half cycle (3 minutes drying / 2.5 minutes regenerating / 30 seconds repressurisation) until the sensor is replaced.

Moisture Override

In certain geographical locations, a dryer can be operated for extended periods with low amounts of water vapour in the inlet air (for example, some countries can have an ambient temperature up to +40°C in summer and as low as -40°C in winter). As the dryer must be sized for summer conditions, during winter, months, EST will save the user air, energy & money.

However, due to the way a desiccant bed adsorbs water vapour, during winter months with low levels of water vapour in the incoming air, the saturation profile of the desiccant bed changes and a condition may occur where the bed becomes too saturated to be regenerated by the standard purge regeneration cycle.

Therefore, the CDAS HL / OFAS HL / FBP HL controller also incorporates a safety feature to protect the desiccant material. The safety feature, called Moisture Override activates after 30 minutes (1800 seconds), interrupting the ECO energy management function and changing the drying columns over.

Once Moisture Override has been activated, the dryer will revert to a fixed timing cycle for 3 half cycles before going back into energy saving mode (if the outlet dewpoint is again lower than the ECO setpoint). This allows energy savings to be realised without causing damage to the desiccant bed.

The diagram below illustrates the EST timing cycle of a CDAS HL / OFAS HL / FBP HL operating at variable inlet conditions (EST active, Moisture Override Activated).

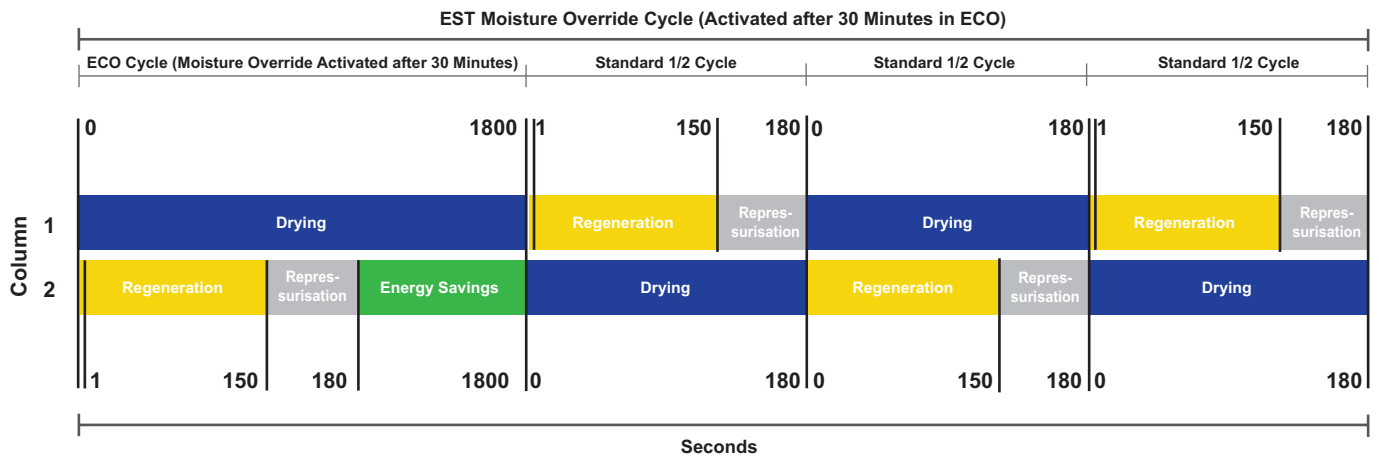

Important Notes:

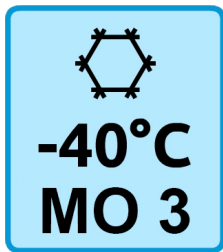

- When the drying cycle is being extended, “ECO” will be displayed on the controller screen.
- The length of time spent in “ECO” energy saving mode is dependent upon the moisture loading of the incoming compressed air and the subsequent outlet dewpoint.
- EST energy saving mode can extend the drying cycle from 180 seconds (3 minutes) up to 1800 seconds (30 minutes).
- When moisture override is active, the “MO” icon will be displayed below the outlet dewpoint.
- The number after MO denoted the number of ½ cycles remaining before the dryer can once again enter “ECO” energy saving mode.
- The default moisture override time of 1800 seconds (30 minutes) and the subsequent activation of the standard timing cycle for 3 half cycles can be modified by a trained engineer (please note, that changing these parameters can affect the performance of the dryer and should only be carried out following consultation with Parker)

Purge Economy

Purge economy requires a physical connection between the air compressor and the dryer and is designed to save energy (by stopping purge air) when the air compressor goes off load. There are two modes for purge economy.

- **Mode 1 (Option)** - When Purge Economy is activated, the dryer continues until the end of the regeneration cycle, closes the exhaust valve then stops the cycle after repressurisation of the off-line column.
- **Mode 2 (Default)** - When Purge Economy is activated, the dryer immediately closes the exhaust valve to repressurise the off-line column then stops the cycle.

Important Notes:

- EST & Purge economy can be used together.
 - Purge economy takes priority over EST .
 - Purge Economy - (**Default**): If dryer is in EST ECO mode and the compressor goes off-load, purge economy is activated and the dry will immediately stop (Mode2)
 - Purge Economy - (Option): If dryer is in EST ECO mode and the compressor goes off-load, purge economy is activated and the dry will continue to the end of its ½ cycle then stop (Mode 1)
 - Once the compressor is brought back on-load, the dryer will immediately change over and resume drying on the opposite column
 - When purge economy is active, the green ECO icon will be displayed.



OPERATING THE EQUIPMENT

CDAS HL / OFAS HL / FBP HL Electronic Controller & Display

CDAS HL / OFAS HL / FBP HL dryers are supplied as standard with an electronic control system which includes a dewpoint sensor and colour display.

The type of dewpoint sensor fitted differs depending upon the dryer range and outlet dewpoint. The table below highlights the sensors used.

Dryer Model	Pressure Dewpoint	
	-20°C / -40°C (-4°F / -40°F)	-70°C (-100°F)
CDAS HL	Parker Dewpoint Sensor (PDS)	Hygrometer
OFAS HL	Parker Dewpoint Sensor (PDS)	Hygrometer
FBP HL	Hygrometer	Hygrometer

In addition to providing the basic control of the adsorption dryer and the EST energy management system, the CDAS HL / OFAS HL / FBP HL controller also provides additional functionality which includes:

- Remote Stop / Start
- Purge Economy
- Remote Alarm Connection
- Dedicated dewpoint alarm
- MODBUS connectivity
- 4-20mA Dewpoint Retransmission

Important Note: The above functions all require additional external connections

OPERATING THE DRYER

Displays and Indicators

Standard CDAS HL / OFAS HL / FBP HL dryers are fitted with a 3.45" colour TFT display (Please note - this is not a touchscreen). Below is an example of the basic display format.

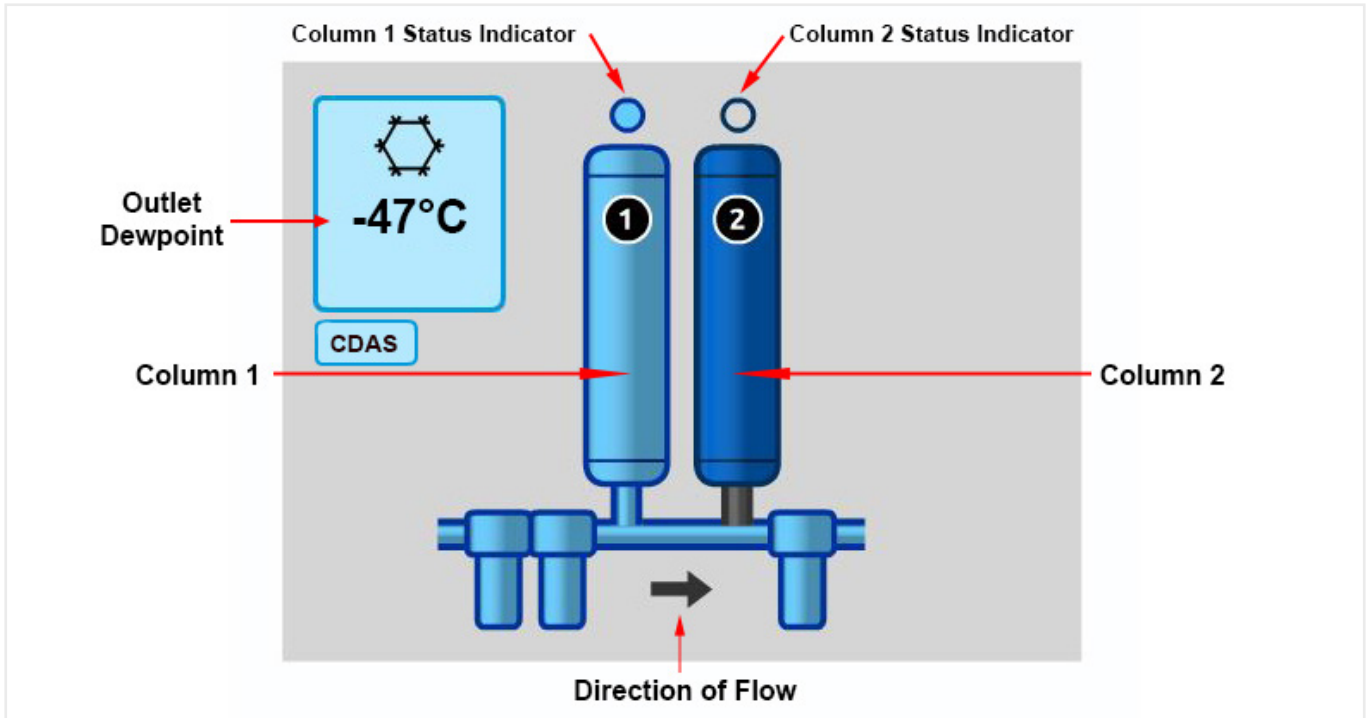

Important Note:



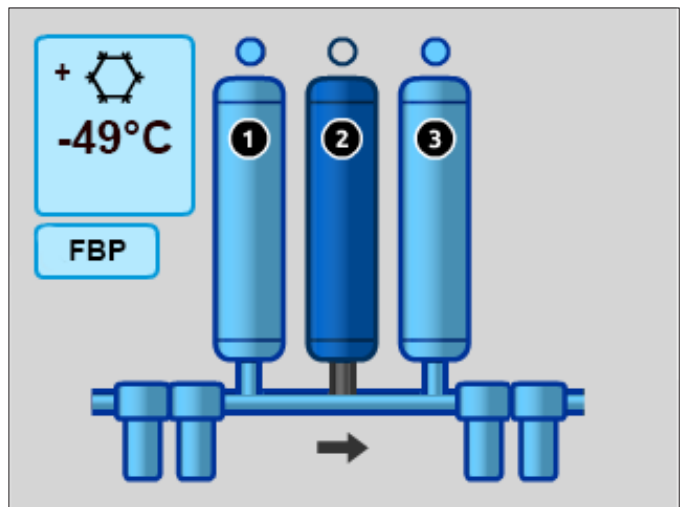
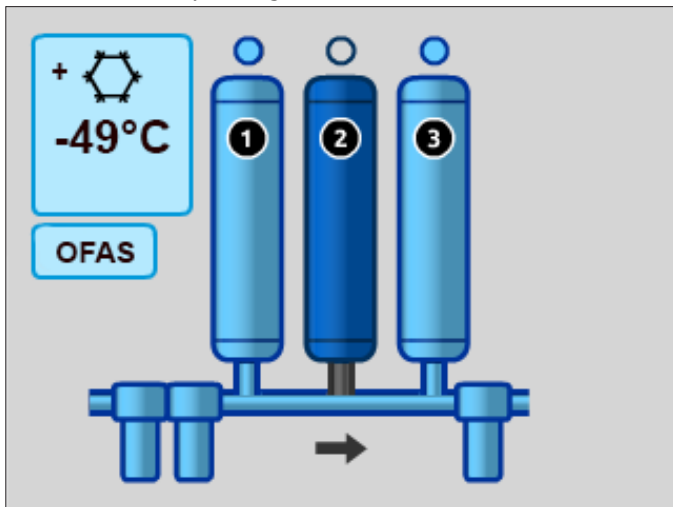







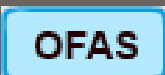

OFAS & FBP HL dryer images will also include Column 3

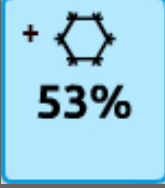
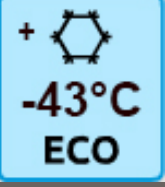
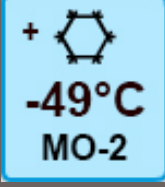

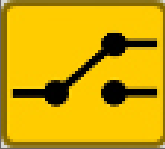
Column Status Indicators

	Dark blue ring with light blue fill (Light Blue Column) indicates that the column is online.		Dark grey ring with a dark grey fill (Dark Green Column) indicates that the column is in Economy mode.
	Dark blue ring with no fill (Dark Blue Column) indicates that the column is regenerating.		Dark grey ring with a light grey fill (Light Grey Column) indicates that the column is in Standby.
	Dark grey ring with a gradient fill (Dark Grey Column) indicates that the column is re-pressurising.		Dark grey ring with a dark grey fill (Dark Grey Column) Indicates that the column is fully pressurised during Purge Economy Mode

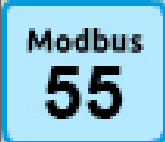
Screen Icons

	<p>"CDAS" = Indicates controller has been set up for a CDAS dryer</p>		<p>"OFAS" = Indicates controller has been set up for a OFAS dryer</p>
	<p>"FBP" = Indicates controller has been set up for a FBP dryer</p>		<p>Flashing "+" = Dryer heartbeat, used to identify controller and screen are communicating</p>
	<p>"Numerical value in °C or °F" = Real time dryer Outlet Pressure Dewpoint</p>		<p>"Numerical value %" = Percentage of time dryer spent in energy saving mode. Shown for 3 seconds at the start of a new 1/2 cycle</p>
	<p>"ECO" Indicates dryer is in EST - Energy Saving Mode</p>		<p>"MO- Numerical Value" "MO-" = Indicates dryer is in Moisture Override mode "Numerical Value" = The numerical value represents the number of remaining moisture override cycles before dryer can re-enter EST energy saving mode.</p>
	<p>"ERR" = Dewpoint sensor error Dryer will operate in fixed timing cycle when a dewpoint sensor error is detected A general alarm fault will also be activated</p>		<p>General Fault Alarm Indicates when the General Fault Alarm Relay has been activated</p>
	<p>Dewpoint Alarm - General Fault Relay Yellow Background = Dewpoint Alarm General Fault Alarm Relay will be activated and General Fault Alarm icon will also be present on screen</p>		<p>Dewpoint Alarm - Dedicated Dewpoint Fault Relay Yellow Background = Dewpoint Alarm No General Fault Alarm icon will be displayed Dedicated Dewpoint Alarm Relay will be activated</p>
	<p>Green "ECO" icon = Purge Economy Activated</p>		<p>MODBUS ICON = Indicated Modbus is connected Numerical Value = Modbus ID (Node)</p>
	<p>Remote Stop / Start Icon Grey Box with diagonal line through = Remote Stop / Start connected - Switch Open, Dryer Operating</p>		<p>Remote Stop / Start Icon Blue Box = Remote Stop / Start connected - Switch Closed, Dryer Stopped</p>

Dryer Start Up & Shut Down Procedures

Dryer Start Up

1. Ensure that the isolation valves on the inlet and the outlet of the dryer are closed.
2. Switch on the dryer electrical supply and verify that the display illuminates.
3. Slowly open the isolation valve on the inlet of the dryer and verify that there are no leaks.
4. Test the condensate drains of the filters by manually opening and closing the float drain (warning - pressurised air or condensate will be present) and ensure they are discharging correctly into a suitable collection vessel.

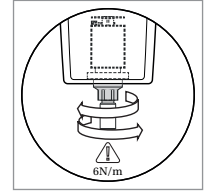

Important Note: The pressure gauges on the dryer will not indicate pressure until the dryer begins to cycle.

5. Slowly open the outlet isolation valve to allow the system to pressurise. Do not open the valve fully until the down stream system has reached the correct operating pressure.

The dryer is designed for continuous use and, once running, requires no further operator intervention.

Display - Start Up

When applying power to the dryer, the controller display will show the software version number for 10 seconds.

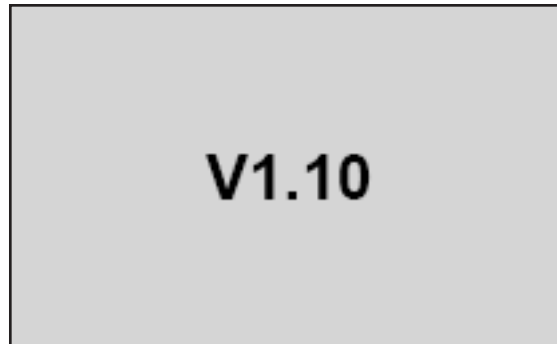

Important Notes:

Start up column

At first start-up from commissioning, the dryer will automatically start drying on column 1. If the dryer has been operated previously, the controller will remember its last known position from power off and resume from where it left off in the cycle.

Dewpoint Display

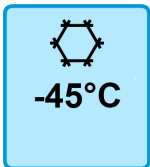

When the dryer is operating, the outlet dewpoint will be shown in real time in the upper left corner of the display.

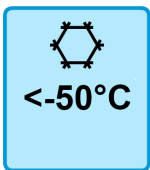

CDAS HL and OFAS HL -20°C / -40°C PDP dryers are supplied as standard with the Parker Dewpoint Sensor (PDS).

The accuracy range of the PDS is -50°C PDP to 0°C PDP. When the outlet dewpoint is better than -50°C, the display will only show <-50°C.

For example, if the actual outlet dewpoint is -55°C, the display will show <-50°C.

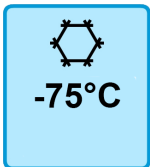

CDAS HL -70°C PDP variants / OFAS HL -70°C PDP variants / FBP HL all variants are fitted with a dewpoint hygrometer with an accuracy range of -100°C to +20°C.

The dewpoint display on these models will always be in real time.

For example, if the outlet dewpoint is -75°C, the display will show -75°C.

Dryer Shut Down

To shut down and depressurise the dryer:

1. Turn OFF the dryer electrical supply at the isolator.
2. Close the isolation valve on the outlet followed by the isolation valve on the inlet.
3. Slowly open the drain ball valve on the outlet filter to depressurise the dryer.

Important Note: A small amount of air may be trapped between the inlet isolation valve and the dryer inlet. This can be removed by manually opening and closing the inlet filter float drain.

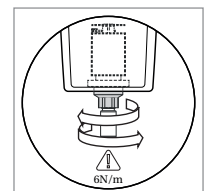

Display During A Typical Drying Cycle (CDAS HL shown)

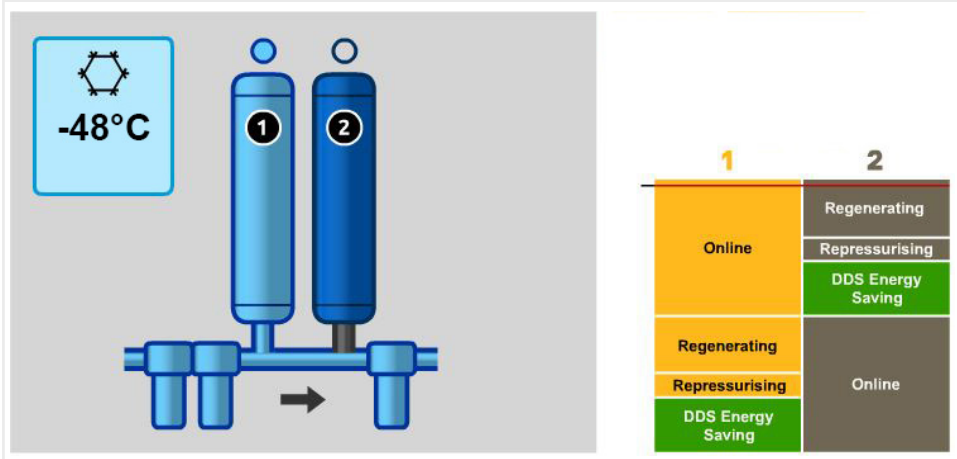

VALVE	VALVE STATUS	COLUMN STATUS			ENERGY SAVING	COLUMN PRESSURISED
Inlet 1	Open	Column 1	On-line	Drying	-	Yes
Exhaust	Open					
Inlet 2	Closed	Column 2	Off-line	Regenerating	No	No

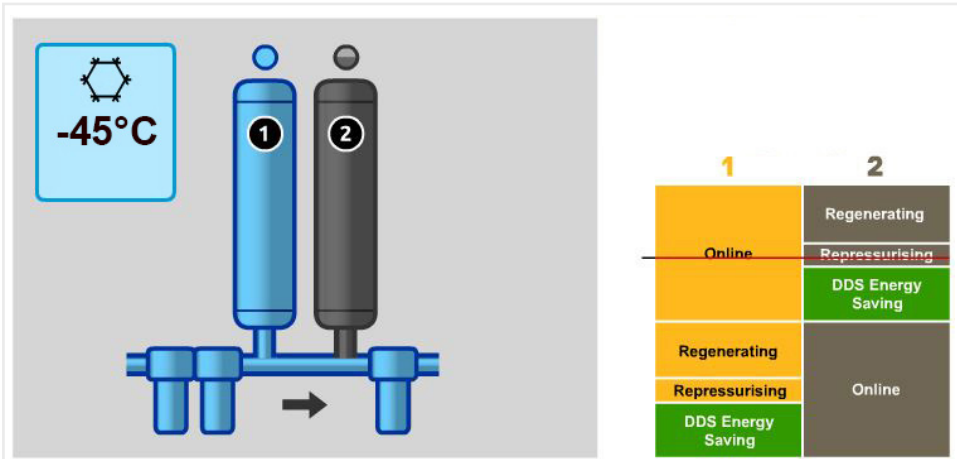

VALVE	VALVE STATUS	COLUMN STATUS			ENERGY SAVING	COLUMN PRESSURISED
Inlet 1	Open	Column 1	On-line	Drying	-	Yes
Exhaust	Closed					
Inlet 2	Closed	Column 2	Off-line	Repressurising	No	Yes

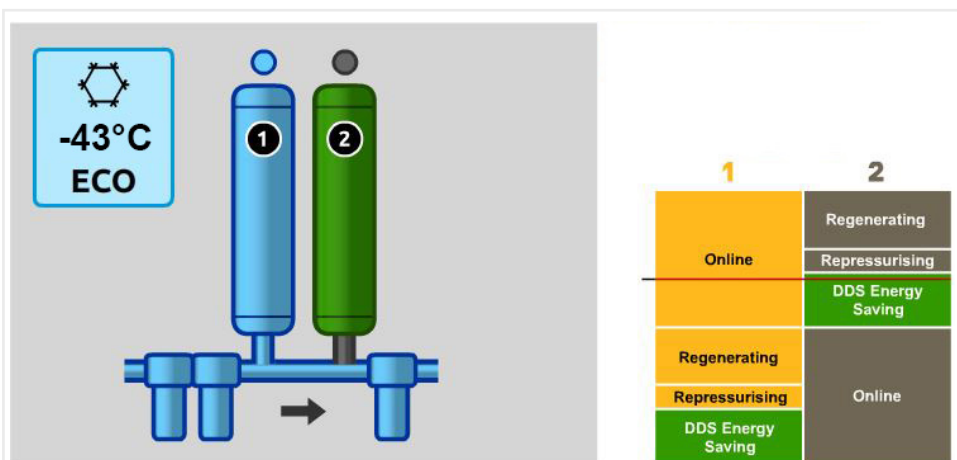

VALVE	VALVE STATUS	COLUMN STATUS			ENERGY SAVING	COLUMN PRESSURISED
Inlet 1	Open	Column 1	On-line	Drying	-	Yes
Exhaust	Closed					
Inlet 2	Closed	Column 2	Off-line	ECO	Yes	Yes

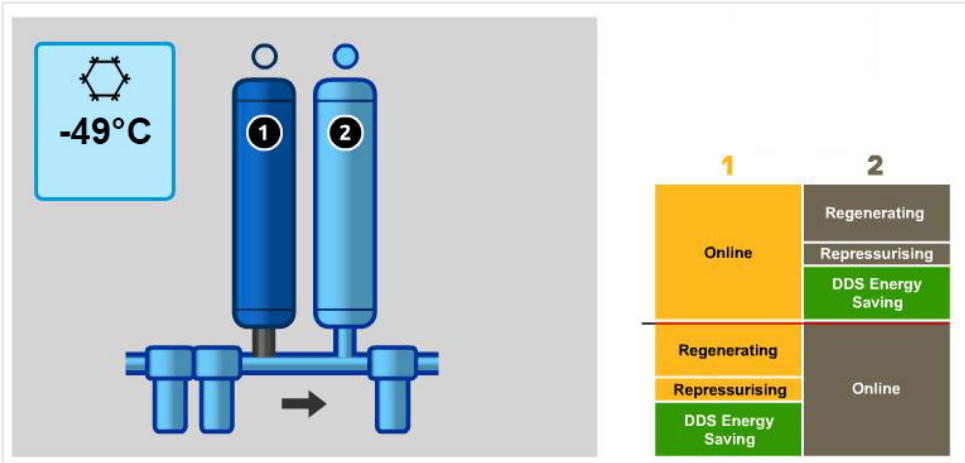

VALVE	VALVE STATUS	COLUMN STATUS		ENERGY SAVING	COLUMN PRESSURISED
Inlet 1	Closed	Column 1	Off-line	Regenerating	No
Exhaust	Open			-	
Inlet 2	Open	Column 2	Off-line	Drying	Yes

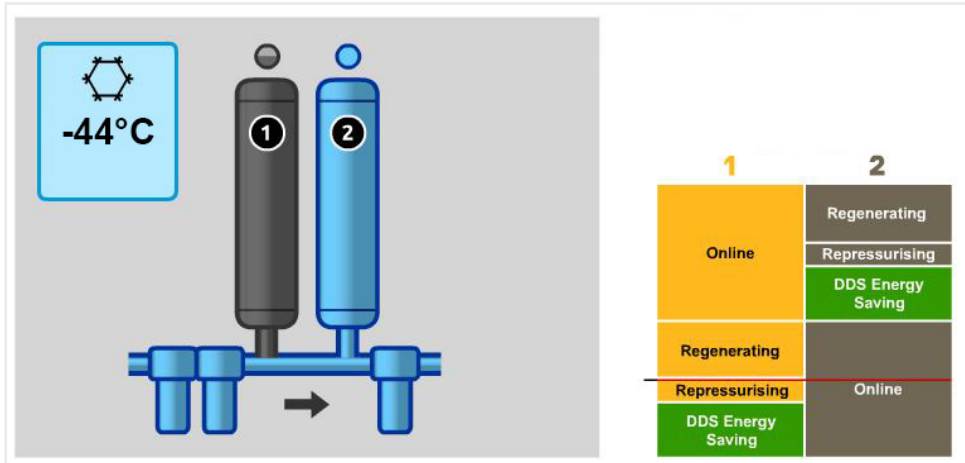

VALVE	VALVE STATUS	COLUMN STATUS		ENERGY SAVING	COLUMN PRESSURISED
Inlet 1	Closed	Column 1	Off-line	Repressurisation	Yes
Exhaust	Closed			-	
Inlet 2	Open	Column 2	On-line	Drying	Yes

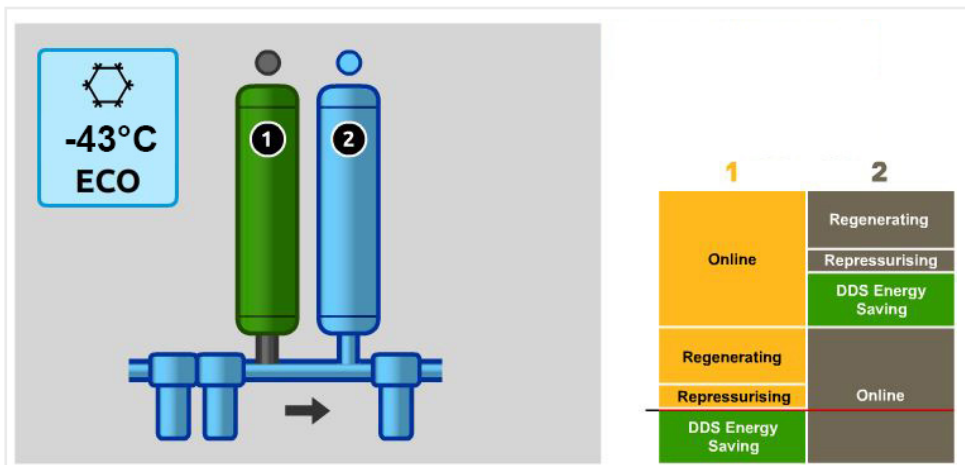

VALVE	VALVE STATUS	COLUMN STATUS		ENERGY SAVING	COLUMN PRESSURISED
Inlet 1	Closed	Column 1	Off-line	ECO	Yes
Exhaust	Closed			-	
Inlet 2	Open	Column 2	On-line	Drying	Yes

Important Notes:

Dewpoint Alarm Delay at Start Up

Following application of power there is a dewpoint alarm delay of 30 minutes (customisable by a trained engineer using the Parker ADS service software). During the alarm delay period, should the dryer outlet dewpoint be worse than the dewpoint alarm setpoint, the alarm relay will not be triggered.

DEWPOINT SET POINT SELECTED (DRYER OUTLET DEWPOINT)	DEFAULT DEWPOINT ALARM SET POINT	Dewpoint Alarm Delay at Start-up	Dewpoint Alarm Fault Relay Activation Delay
-20°C (-4°F)	-5°C (+23°F)	30 minutes	10 minutes
-40°C (-40°F)	-20°C (-4°F)	30 minutes	10 minutes
-70°C (-100°F)	-56°C (-68°F)	30 minutes	10 minutes

Dewpoint Alarm Fault - Activation Delay

Once the dewpoint alarm delay at start-up period has passed, any dewpoint fault is subject to an alarm relay activation delay.

Should the dryer outlet dewpoint be worse than the dewpoint alarm setpoint, the controller will not activate the general alarm relay (or dewpoint alarm relay if fitted and activated) unless the outlet dewpoint fault is longer than 10 minutes (default value is customisable by a trained engineer using the Parker ADS service software)

CDAS HL / OFAS HL / FBP HL Display Icons - Alarm Activation

Dewpoint Alarm - General Fault Relay Activated

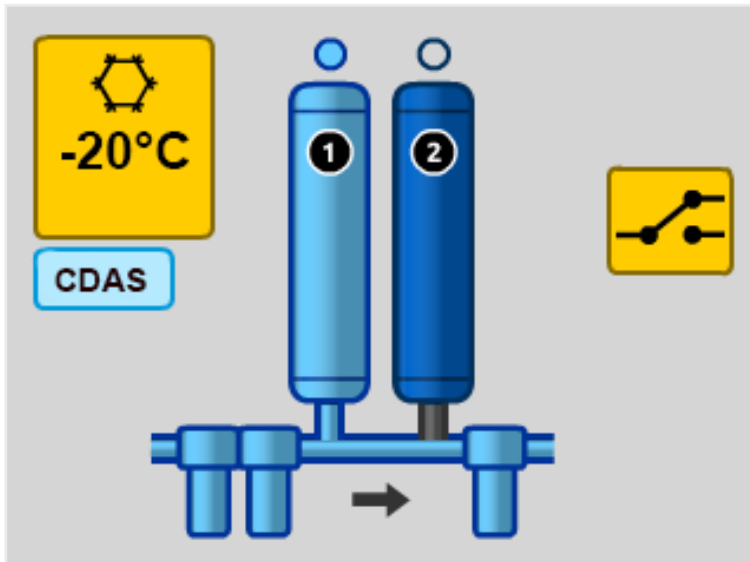

Dewpoint Alarm - Dedicated Dewpoint Relay Fitted and Activated

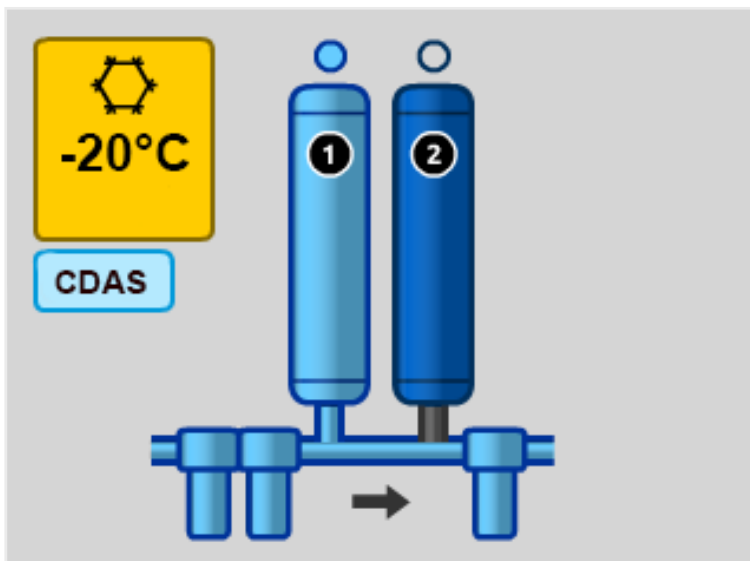

Remote Stop Connected - Remote Switch Open - Dryer Operating (OFAS model shown)

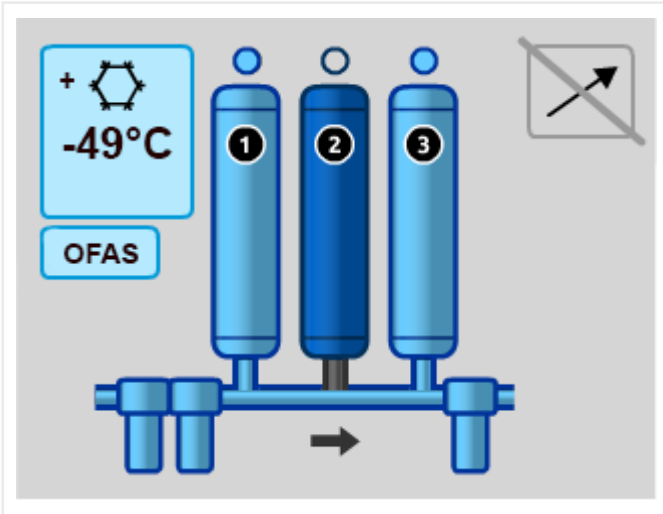

Remote Stop Connected - Remote Switch Closed - Dryer Stopped (OFAS Model shown)

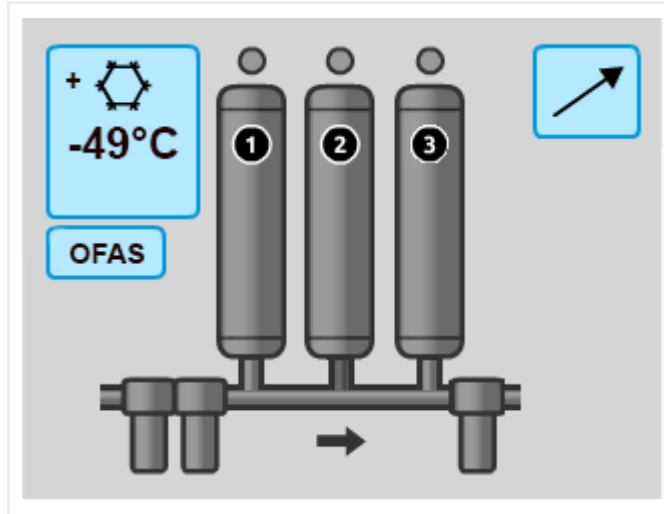

Yellow Filter - Static Spanner Image - Filter Service Due
Yellow Filter - Flashing Spanner Image - Filter Service Overdue (FBP model shown)

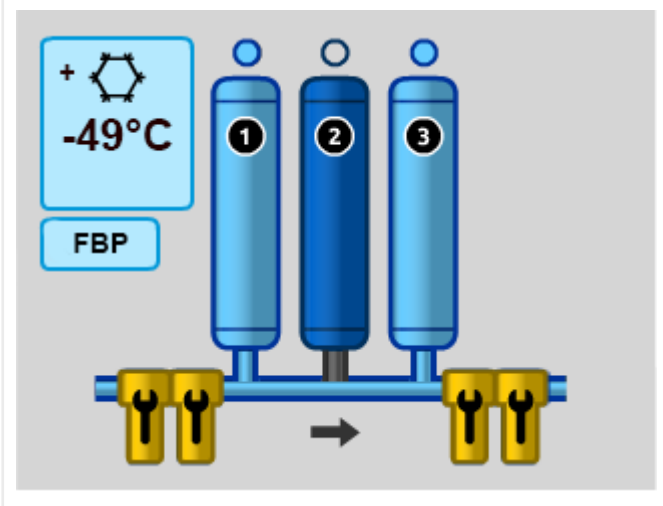

Yellow Dryer Columns - Static Spanner Image - Dryer Service Due
Yellow Dryer Columns - Flashing Spanner Image - Dryer Service Overdue (FBP model shown)

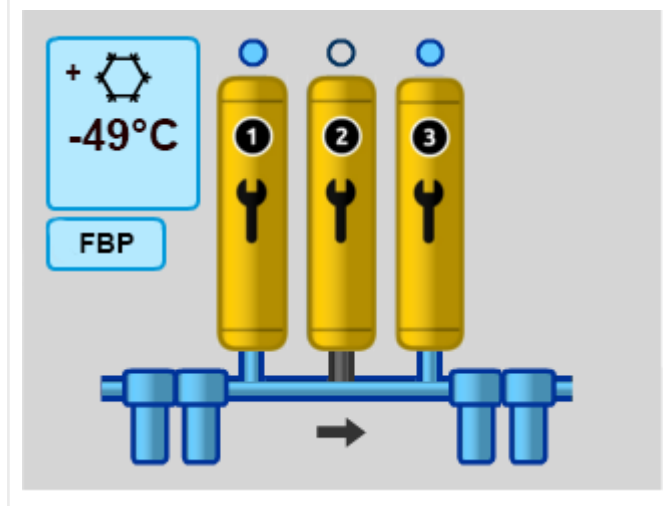

Yellow Filter and Dryer Columns - Static Spanner Image - Filter and Dryer Service Due
Yellow Filter and Dryer Columns - Flashing Spanner Image - Filter and Dryer Service Overdue (FBP model shown)

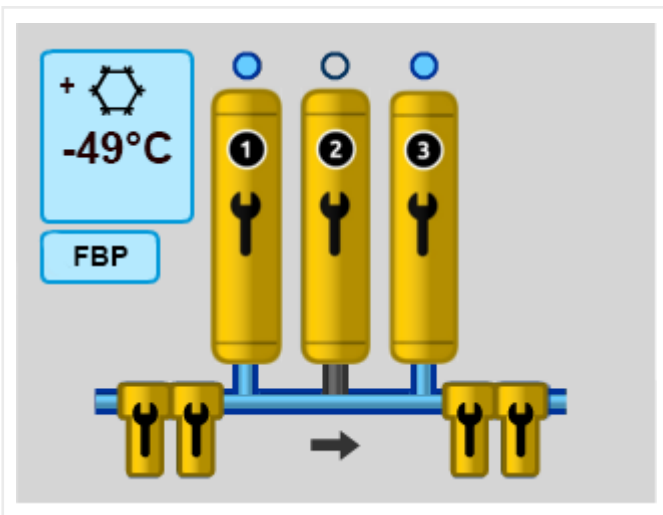









PREVENTATIVE MAINTENANCE

CLEANING

Clean the equipment with a damp cloth only and avoid excessive moisture around any electrical sockets. If required you may use a mild detergent, however do not use abrasives or solvents as they may damage the warning labels on the equipment.

SERVICE INTERVALS

Description of Service Required		Service Recommended Every:					
Component	Operation	Daily	Weekly	3 Months	6 Months	12 Months	60 Months
Dryer	Check POWER ON and STATUS / FAULT indicators.						
Dryer	Check for air leaks.						
Dryer	Check the pressure gauges during purging for excessive back pressure.						
Dryer	Check the condition of electrical supply cables and conduits.						
Dryer	Check for cyclic operation.						
Dryer	Replace the exhaust silencers.						
Filtration	Replace inlet / outlet / control air filter elements. Replace inlet filter / control air filter float drains.						
Dryer	Replace Parker Dewpoint Sensor or Dewpoint Hygrometer transmitter						
Dryer	Replace the outlet check ball						
Dryer	Replace the inlet valves (x 2), exhaust valve (x1) and 5/2 control valves						
Dryer	Replace the Desiccant Cartridges.						
Dryer	Replace the Carbon Cartridges (OFAS / FBP Ranges only).						

Key

	Check		Recommended Service
---	-------	---	---------------------

PREVENTATIVE MAINTENANCE KITS - CDAS HL 050 -085

CATALOGUE NUMBER	DESCRIPTION	12	24	36	48	60	ORDER QTY
M12.FSK.0002	12 Month Filter Service Kit (-20 and -40 dryers)	✓	✓	✓	✓	✓	CDAS HL 050 - CDAS HL 055 (x1)
M12.FSK.1002	12 Month Filter Service Kit (-70 dryer)	✓	✓	✓	✓	✓	CDAS HL 050 - CDAS HL 055 (x1)
M12.FSK.0003	12 Month Filter Service Kit (-20 and -40 dryers)	✓	✓	✓	✓	✓	CDAS HL 060 - CDAS HL 065 (x1)
M12.FSK.1003	12 Month Filter Service Kit (-70 dryer)	✓	✓	✓	✓	✓	CDAS HL 060 - CDAS HL 065 (x1)
M12.FSK.0004	12 Month Filter Service Kit (-20 and -40 dryers)	✓	✓	✓	✓	✓	CDAS HL 070 - CDAS HL 080 (x1)
M12.FSK.1004	12 Month Filter Service Kit (-70 dryer)	✓	✓	✓	✓	✓	CDAS HL 070 - CDAS HL 080 (x1)
M12.FSK.0005	12 Month Filter Service Kit (-20 and -40 dryers)	✓	✓	✓	✓	✓	CDAS HL 085 (x1)
M12.FSK.1005	12 Month Filter Service Kit (-70 dryer)	✓	✓	✓	✓	✓	CDAS HL 085 (x1)
60 Month Filter Service Kits							
M60.DSK.0009	60 Month Filter Service Kit (-20 and -40 dryers)	✗	✗	✗	✗	✓	CDAS HL 050 (x1)
M60.DSK.1009	60 Month Filter Service Kit (-70 dryer)	✗	✗	✗	✗	✓	CDAS HL 050 (x1)
M60.DSK.0010	60 Month Filter Service Kit (-20 and -40 dryers)	✗	✗	✗	✗	✓	CDAS HL 055 (x1)
M60.DSK.1010	60 Month Filter Service Kit (-70 dryer)	✗	✗	✗	✗	✓	CDAS HL 055 (x1)
M60.DSK.0011	60 Month Filter Service Kit (-20 and -40 dryers)	✗	✗	✗	✗	✓	CDAS HL 060 (x1)
M60.DSK.1011	60 Month Filter Service Kit (-70 dryer)	✗	✗	✗	✗	✓	CDAS HL 060 (x1)
M60.DSK.0012	60 Month Filter Service Kit (-20 and -40 dryers)	✗	✗	✗	✗	✓	CDAS HL 065 (x1)
M60.DSK.1012	60 Month Filter Service Kit (-70 dryer)	✗	✗	✗	✗	✓	CDAS HL 065 (x1)
M60.DSK.0013	60 Month Filter Service Kit (-20 and -40 dryers)	✗	✗	✗	✗	✓	CDAS HL 070 (x1)
M60.DSK.1013	60 Month Filter Service Kit (-70 dryer)	✗	✗	✗	✗	✓	CDAS HL 070 (x1)
M60.DSK.0014	60 Month Filter Service Kit (-20 and -40 dryers)	✗	✗	✗	✗	✓	CDAS HL 075 (x1)
M60.DSK.1014	60 Month Filter Service Kit (-70 dryer)	✗	✗	✗	✗	✓	CDAS HL 075 (x1)
M60.DSK.0015	60 Month Filter Service Kit (-20 and -40 dryers)	✗	✗	✗	✗	✓	CDAS HL 080 (x1)
M60.DSK.1015	60 Month Filter Service Kit (-70 dryer)	✗	✗	✗	✗	✓	CDAS HL 080 (x1)
M60.DSK.0016	60 Month Filter Service Kit (-20 and -40 dryers)	✗	✗	✗	✗	✓	CDAS HL 085 (x1)
M60.DSK.1016	60 Month Filter Service Kit (-70 dryer)	✗	✗	✗	✗	✓	CDAS HL 085 (x1)

PREVENTATIVE MAINTENANCE KITS - OFAS HL 050 - 085

CATALOGUE NUMBER	DESCRIPTION	12	24	36	48	60	ORDER QTY
M12.FSK.0011	12 Month Filter Service Kit (-20 and -40 dryers)	✓	✓	✓	✓	✓	OFAS HL 050 - OFAS HL 055 (x1)
M12.FSK.1011	12 Month Filter Service Kit (-70 dryer)	✓	✓	✓	✓	✓	OFAS HL 050 - OFAS HL 055 (x1)
M12.FSK.0012	12 Month Filter Service Kit (-20 and -40 dryers)	✓	✓	✓	✓	✓	OFAS HL 060 - OFAS HL 065 (x1)
M12.FSK.1012	12 Month Filter Service Kit (-70 dryer)	✓	✓	✓	✓	✓	OFAS HL 060 - OFAS HL 065 (x1)
M12.FSK.0013	12 Month Filter Service Kit (-20 and -40 dryers)	✓	✓	✓	✓	✓	OFAS HL 070 (x1)
M12.FSK.1013	12 Month Filter Service Kit (-70 dryer)	✓	✓	✓	✓	✓	OFAS HL 070 (x1)
M12.FSK.0014	12 Month Filter Service Kit (-20 and -40 dryers)	✓	✓	✓	✓	✓	OFAS HL 075 - OFAS HL 080 (x1)
M12.FSK.1014	12 Month Filter Service Kit (-70 dryer)	✓	✓	✓	✓	✓	OFAS HL 075 - OFAS HL 080 (x1)
M12.FSK.1015	12 Month Filter Service Kit (-20 and -40 dryers)	✓	✓	✓	✓	✓	OFAS HL 085 (x1)
M12.FSK.1015	12 Month Filter Service Kit (-70 dryer)	✓	✓	✓	✓	✓	OFAS HL 085 (x1)
60 Month Filter Service Kits							
M60.DSK.0009	60 Month Filter Service Kit (-20 and -40 dryers)	✗	✗	✗	✗	✓	OFAS HL 050 (x1)
M60.DSK.1009	60 Month Filter Service Kit (-70 dryer)	✗	✗	✗	✗	✓	OFAS HL 050 (x1)
M60.DSK.0010	60 Month Filter Service Kit (-20 and -40 dryers)	✗	✗	✗	✗	✓	OFAS HL 055 (x1)
M60.DSK.1010	60 Month Filter Service Kit (-70 dryer)	✗	✗	✗	✗	✓	OFAS HL 055 (x1)
M60.DSK.0011	60 Month Filter Service Kit (-20 and -40 dryers)	✗	✗	✗	✗	✓	OFAS HL 060 (x1)
M60.DSK.1011	60 Month Filter Service Kit (-70 dryer)	✗	✗	✗	✗	✓	OFAS HL 060 (x1)
M60.DSK.0012	60 Month Filter Service Kit (-20 and -40 dryers)	✗	✗	✗	✗	✓	OFAS HL 065 (x1)
M60.DSK.1012	60 Month Filter Service Kit (-70 dryer)	✗	✗	✗	✗	✓	OFAS HL 065 (x1)
M60.DSK.0013	60 Month Filter Service Kit (-20 and -40 dryers)	✗	✗	✗	✗	✓	OFAS HL 070 (x1)
M60.DSK.1013	60 Month Filter Service Kit (-70 dryer)	✗	✗	✗	✗	✓	OFAS HL 070 (x1)
M60.DSK.0014	60 Month Filter Service Kit (-20 and -40 dryers)	✗	✗	✗	✗	✓	OFAS HL 075 (x1)
M60.DSK.1014	60 Month Filter Service Kit (-70 dryer)	✗	✗	✗	✗	✓	OFAS HL 075 (x1)
M60.DSK.0015	60 Month Filter Service Kit (-20 and -40 dryers)	✗	✗	✗	✗	✓	OFAS HL 080 (x1)
M60.DSK.1015	60 Month Filter Service Kit (-70 dryer)	✗	✗	✗	✗	✓	OFAS HL 080 (x1)
M60.DSK.0016	60 Month Filter Service Kit (-20 and -40 dryers)	✗	✗	✗	✗	✓	OFAS HL 085 (x1)
M60.DSK.1016	60 Month Filter Service Kit (-70 dryer)	✗	✗	✗	✗	✓	OFAS HL 085 (x1)

PREVENTATIVE MAINTENANCE KITS - FBP HL 050 - 085

CATALOGUE NUMBER	DESCRIPTION	12	24	36	48	60	ORDER QTY
M12.FSK.0111	12 Month Filter Service Kit (-20 and -40 dryers)	✓	✓	✓	✓	✓	FBP HL 050 - FBP HL 055 (x1)
M12.FSK.1111	12 Month Filter Service Kit (-70 dryer)	✓	✓	✓	✓	✓	FBP HL 050 - FBP HL 055 (x1)
M12.FSK.0112	12 Month Filter Service Kit (-20 and -40 dryers)	✓	✓	✓	✓	✓	FBP HL 060 - FBP HL 065 (x1)
M12.FSK.1112	12 Month Filter Service Kit (-70 dryer)	✓	✓	✓	✓	✓	FBP HL 060 - FBP HL 065 (x1)
M12.FSK.0113	12 Month Filter Service Kit (-20 and -40 dryers)	✓	✓	✓	✓	✓	FBP HL 070 (x1)
M12.FSK.1113	12 Month Filter Service Kit (-70 dryer)	✓	✓	✓	✓	✓	FBP HL 070 (x1)
M12.FSK.0114	12 Month Filter Service Kit (-20 and -40 dryers)	✓	✓	✓	✓	✓	FBP HL 075 - FBP HL 080 (x1)
M12.FSK.1114	12 Month Filter Service Kit (-70 dryer)	✓	✓	✓	✓	✓	FBP HL 075 - FBP HL 080 (x1)
M12.FSK.1115	12 Month Filter Service Kit (-20 and -40 dryers)	✓	✓	✓	✓	✓	FBP HL 085 (x1)
M12.FSK.1115	12 Month Filter Service Kit (-70 dryer)	✓	✓	✓	✓	✓	FBP HL 085 (x1)
60 Month Filter Service Kits							
M60.DSK.0009	60 Month Filter Service Kit (-20 and -40 dryers)	✗	✗	✗	✗	✓	FBP HL 050 (x1)
M60.DSK.1009	60 Month Filter Service Kit (-70 dryer)	✗	✗	✗	✗	✓	FBP HL 050 (x1)
M60.DSK.0010	60 Month Filter Service Kit (-20 and -40 dryers)	✗	✗	✗	✗	✓	FBP HL 055 (x1)
M60.DSK.1010	60 Month Filter Service Kit (-70 dryer)	✗	✗	✗	✗	✓	FBP HL 055 (x1)
M60.DSK.0011	60 Month Filter Service Kit (-20 and -40 dryers)	✗	✗	✗	✗	✓	FBP HL 060 (x1)
M60.DSK.1011	60 Month Filter Service Kit (-70 dryer)	✗	✗	✗	✗	✓	FBP HL 060 (x1)
M60.DSK.0012	60 Month Filter Service Kit (-20 and -40 dryers)	✗	✗	✗	✗	✓	FBP HL 065 (x1)
M60.DSK.1012	60 Month Filter Service Kit (-70 dryer)	✗	✗	✗	✗	✓	OFAS HL 065 (x1)
M60.DSK.0013	60 Month Filter Service Kit (-20 and -40 dryers)	✗	✗	✗	✗	✓	FBP HL 070 (x1)
M60.DSK.1013	60 Month Filter Service Kit (-70 dryer)	✗	✗	✗	✗	✓	FBP HL 070 (x1)
M60.DSK.0014	60 Month Filter Service Kit (-20 and -40 dryers)	✗	✗	✗	✗	✓	FBP HL 075 (x1)
M60.DSK.1014	60 Month Filter Service Kit (-70 dryer)	✗	✗	✗	✗	✓	FBP HL 075 (x1)
M60.DSK.0015	60 Month Filter Service Kit (-20 and -40 dryers)	✗	✗	✗	✗	✓	FBP HL 080 (x1)
M60.DSK.1015	60 Month Filter Service Kit (-70 dryer)	✗	✗	✗	✗	✓	FBP HL 080 (x1)
M60.DSK.0016	60 Month Filter Service Kit (-20 and -40 dryers)	✗	✗	✗	✗	✓	FBP HL 085 (x1)
M60.DSK.1016	60 Month Filter Service Kit (-70 dryer)	✗	✗	✗	✗	✓	FBP HL 085 (x1)

12 MONTH PM KIT CONTENTS - CDAS HL 050 - 085

CDAS HL -20°C PDP / -40°C PDP dryers

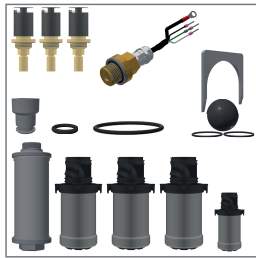

CATALOGUE NO'S	DESCRIPTION	CONTENTS
M12.FSK.0002 M12.FSK.0003 M12.FSK.0004 M12.FSK.0005	Kit: 12 month service	AO grade filter elements (x2) AA grade filter elements (x2) Filter Drains (x3) Silencer element (x1) Parker Dewpoint Sensor (x1) Outlet check ball (x1) Fixed orifice for hygrometer housing (x1) Horseshoe spacer (x1) O-rings (x4)

CDAS HL -70°C PDP dryers



CATALOGUE NO'S	DESCRIPTION	CONTENTS
M12.FSK.1002 M12.FSK.1003 M12.FSK.1004 M12.FSK.1005	Kit: 12 month service	AO grade filter elements (x2) AA grade filter elements (x2) Filter Drains (x3) Silencer element (x1) Dewpoint hygrometer transmitter (x1) Outlet check ball (x1) Fixed orifice for hygrometer housing (x1) Horseshoe spacer (x1) O-rings (x4)

12 MONTH PM KIT CONTENTS - OFAS HL 050 - 085

OFAS HL -20°C PDP / -40°C PDP dryers



CATALOGUE NO'S	DESCRIPTION	CONTENTS
M12.FSK.0011 M12.FSK.0012 M12.FSK.0013 M12.FSK.0014 M12.FSK.0015	Kit: 12 month service	AO grade filter elements (x2) AA grade filter elements (x2) Filter Drains (x3) Silencer element (x1) Parker Dewpoint Sensor (x1) Carbon cartridge (x1) Outlet check ball (x1) Fixed orifice for hygrometer housing (x1) Horseshoe spacer (x1) O-rings (x4) Taper drift tool for carbon cartridge (x1)

OFAS HL -70°C PDP dryers



CATALOGUE NO'S	DESCRIPTION	CONTENTS
M12.FSK.1011 M12.FSK.1012 M12.FSK.1013 M12.FSK.1014 M12.FSK.1015	Kit: 12 month service	AO grade filter elements (x2) AA grade filter elements (x2) Filter Drains (x3) Silencer element (x1) Dewpoint hygrometer transmitter (x1) Carbon cartridge (x1) Outlet check ball (x1) Fixed orifice for hygrometer housing (x1) Horseshoe spacer (x1) O-rings (x4) Taper drift tool for carbon cartridge (x1)

12 MONTH PM KIT CONTENTS - FBP HL 050 - 085 UPGRADE (12 Month service kit including hygrometer upgrade kit)

FBP HL -20°C PDP / -40°C PDP dryers



CATALOGUE NO'S	DESCRIPTION	CONTENTS
M12.FSK.0111 M12.FSK.0112 M12.FSK.0113 M12.FSK.0114 M12.FSK.0115	Kit: 12 month service	AO grade filter elements (x2) AA grade filter elements (x3) Filter Drains (x3) Silencer element (x1) Dewpoint hygrometer assembly (x1) Carbon Cartridge (x1) Outlet check ball (x1) Horseshoe spacer (x1) O-rings (x3) Taper drift tool for carbon cartridge (x1)

FBP HL -70°C PDP dryers



CATALOGUE NO'S	DESCRIPTION	CONTENTS
M12.FSK.1111 M12.FSK.1112 M12.FSK.1113 M12.FSK.1114 M12.FSK.1115	Kit: 12 month service	AO grade filter elements (x2) AA grade filter elements (x3) Filter Drains (x3) Silencer element (x1) Dewpoint hygrometer transmitter (x1) Carbon Cartridge (x1) Outlet check ball (x1) Fixed orifice for hygrometer housing (x1) Horseshoe spacer (x1) O-rings (x3) Taper drift tool for carbon cartridge (x1)

60 MONTH PM KIT CONTENTS - CDAS HL / OFAS HL / FBP HL 050 - 085

CDAS HL / OFAS HL / FBP HL -20°C PDP / -40°C PDP dryers

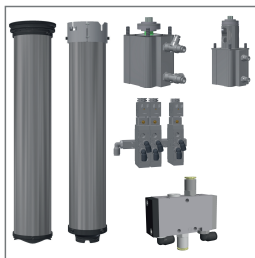

CATALOGUE NO'S	DESCRIPTION	CONTENTS
M60.DSK.0009 M60.DSK.0010 M60.DSK.0011 M60.DSK.0012 M60.DSK.0013 M60.DSK.0014 M60.DSK.0015 M60.DSK.0016	Kit: 60 month service	Desiccant cartridges Inlet valves (x2) Exhaust valve (x1) Control valve (x1) QRV valve (x1) O-rings (x4)

CDAS HL / OFAS HL / FBP HL -70°C PDP

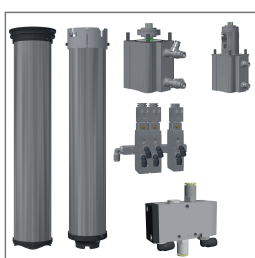

CATALOGUE NO'S	DESCRIPTION	CONTENTS
M60.DSK.1009 M60.DSK.1010 M60.DSK.1011 M60.DSK.1012 M60.DSK.1013 M60.DSK.1014 M60.DSK.1015 M60.DSK.1016	Kit: 60 month service	Desiccant cartridges Inlet valves (x2) Exhaust valve (x1) Control valve (x1) QRV valve (x1) O-rings (x4)

TECHNICAL SPECIFICATION

TECHNICAL SPECIFICATION

Dryer Performance

DRYER MODEL	PRESSURE DEWPOINT (STANDARD)		ISO 8573-1:2010 WATER CLASSIFICATION	PRESSURE DEWPOINT (OPTIONAL)		ISO 8573-1:2010 WATER CLASSIFICATION	PRESSURE DEWPOINT (OPTIONAL)		ISO 8573-1:2010 WATER CLASSIFICATION
	°C	°F	(STANDARD)	°C	°F	(OPTIONAL)	°C	°F	(OPTIONAL)
CDAS HL	-40	-40	Class 2.2.2	-70	-100	Class 2.1.2	-20	-4	Class 2.3.2
OFAS HL	-40	-40	Class 2.2.0	-70	-100	Class 2.1.0	-20	-4	Class 2.3.0
FBP HL	-40	-40	Class 1.2.0	-70	-100	Class 1.1.0	-	-	-

Important Note Regarding -70°C (-100°F) Dewpoint.

A compressed air dryer supplying a pressure dewpoint of -70°C (-100°F) requires a different desiccant fill to dryers supplying a standard -40°C / -20°C pressure dewpoint. During shipping, desiccant material adsorbs atmospheric moisture. Following installation, commissioning and initial operation, the dryer will start to "dry down" until it provides the desired -70°C (-100°F). Once achieved, the dryer will continue to supply air at the required dewpoint, however it is important to note that the dry down period may take several days / weeks to achieve the -70°C (-100°F) dewpoint.

Technical Data

DRYER MODEL	MIN OPERATING PRESSURE		MAX OPERATING PRESSURE		MIN OPERATING TEMPERATURE		MAX OPERATING TEMPERATURE		MAX AMBIENT TEMPERATURE	
	BAR G	PSI G	BAR G	PSI G	°C	°F	°C	°F	°C	°F
CDAS/OFAS/FBP HL	4	58	16	232	5	41	50	122	55	131

Flow Rates

DRYER MODEL	Pipe Size BSPP or NPT	INLET FLOW RATE			
		L/S	M ³ /MIN	M ³ /HR	CFM
CDAS/OFAS/FBP HL 050	1/2"	15	0.92	55	32
CDAS/OFAS/FBP HL 055	1/2"	19	1.17	70	41
CDAS/OFAS/FBP HL 060	1/2"	25	1.50	90	53
CDAS/OFAS/FBP HL 065	1/2"	31	1.84	110	65
CDAS/OFAS/FBP HL 070	3/4"	42	2.51	150	88
CDAS/OFAS/FBP HL 075	1"	51	3.09	185	109
CDAS/OFAS/FBP HL 080	1"	61	3.67	220	129
CDAS/OFAS/FBP HL 085	1 1/2"	83	5.01	300	177

Stated flows are for operation at 7 bar g (100 psi g / 0.7 MPa g) with reference to 20°C, 1 bar a, 0% relative water vapour pressure.

Product Selection & Correction Factors

For correct operation, compressed air dryers must be sized using for the minimum pressure, maximum temperature and maximum flow rate of the installation. To select a dryer, first calculate the MDC (Minimum Drying Capacity) using the formula below then select a dryer from the flow rate table above with a flow rate equal to or above the MDC.

$$\text{Minimum Drying Capacity} = \text{System Flow} \times \text{CFIT} \times \text{CFAT} \times \text{CFP} \times \text{CFD}$$

CFIT - Correction Factor Maximum Inlet Temperature

MAXIMUM INLET TEMPERATURE	°C	25	30	35	40	45	50
	°F	77	86	95	104	113	122
CORRECTION FACTOR		1.00	1.00	1.00	1.04	1.14	1.37

CFAT - Correction Factor Maximum Ambient Temperature

MAXIMUM AMBIENT TEMPERATURE	°C	25	30	35	40	45	50
	°F	77	86	95	104	113	122
CORRECTION FACTOR		1.00	1.00	1.00	1.00	1.00	1.00

CFP - Correction Factor Maximum Inlet Pressure

MAXIMUM INLET PRESSURE	BAR G	4	5	6	7	8	9	10	11	12	13	14	15	16
	PSI G	58	73	87	100	116	131	145	160	174	189	203	218	232
CORRECTION FACTOR		1.60	1.33	1.14	1.00	0.89	0.80	0.73	0.67	0.62	0.57	0.53	0.50	0.47

CFD - Correction Factor Dewpoint

MAXIMUM INLET TEMPERATURE	°C	-20	-40	-70
	°F	-4	-40	-100
CORRECTION FACTOR		0.91	1.00	2.00

Electrical Data

	DRYER MODEL							
	CDAS / OFAS / FBP HL 050	CDAS / OFAS / FBP HL 055	CDAS / OFAS / FBP HL 060	CDAS / OFAS / FBP HL 065	CDAS / OFAS / FBP HL 070	CDAS / OFAS / FBP HL 075	CDAS / OFAS / FBP HL 080	CDAS / OFAS / FBP HL 085
Supply Voltage (Standard)	85 - 265V 1PH 50/60Hz							
Supply Voltage (optional)	24V DC							

Environmental Data

RELATIVE HUMIDITY	55%
IP RATING	IP55, indoor use only
POLLUTION DEGREE ¹	2
MAXIMUM ALTITUDE	800 m (2625) (ft)
NOISE	< 75 dB(A)

¹ Pollution Degree 2 indicates that in order for this equipment to operate safely, only non-conductive pollution (i.e. solids, liquids or ionised gases) or temporary condensation may be present within the environment.

APPROVALS COMPLIANCE AND EXEMPTIONS

Approvals

Safety and Electromagnetic Compatibility

This equipment has been tested and complies with the following European Standards:

BS EN 60204-1:2006 (Including: Amendment1:2009) - Safety of machinery. Electrical equipment of machines. General requirements.

EN61326: 2006 - Electrical Equipment for Measurement, Control, and Laboratory use, EMC Requirements.

EN 55011:2009 (Including: Amendment1:2010) - Industrial, scientific and medical equipment. Radio-frequency disturbance characteristics. Limits and methods of measurement.

Generally in accordance with ASMEVIII Div 1 : 2010 + 2011a Addenda.

3rd Party Performance Verification

OIL-X Coalescing Filters tested in accordance with ISO12500-1 & ISO8573-4

OIL-X Dry Particulate Filters tested in accordance with ISO8573-4

CDAS HL / OFAS / FBPHL Dryers have been tested in accordance with ISO7183 and proven to meet the requirements of ISO 8573-1:2010 Classes 1, 2 and 3 for water.

Performance validation independently verified by Lloyds Register

APPROVALS, ACCREDITATIONS AND ASSOCIATIONS



ISO9001:2000 ISO14001



INTERNATIONAL APPROVALS



CDAS HL WEIGHTS AND DIMENSIONS

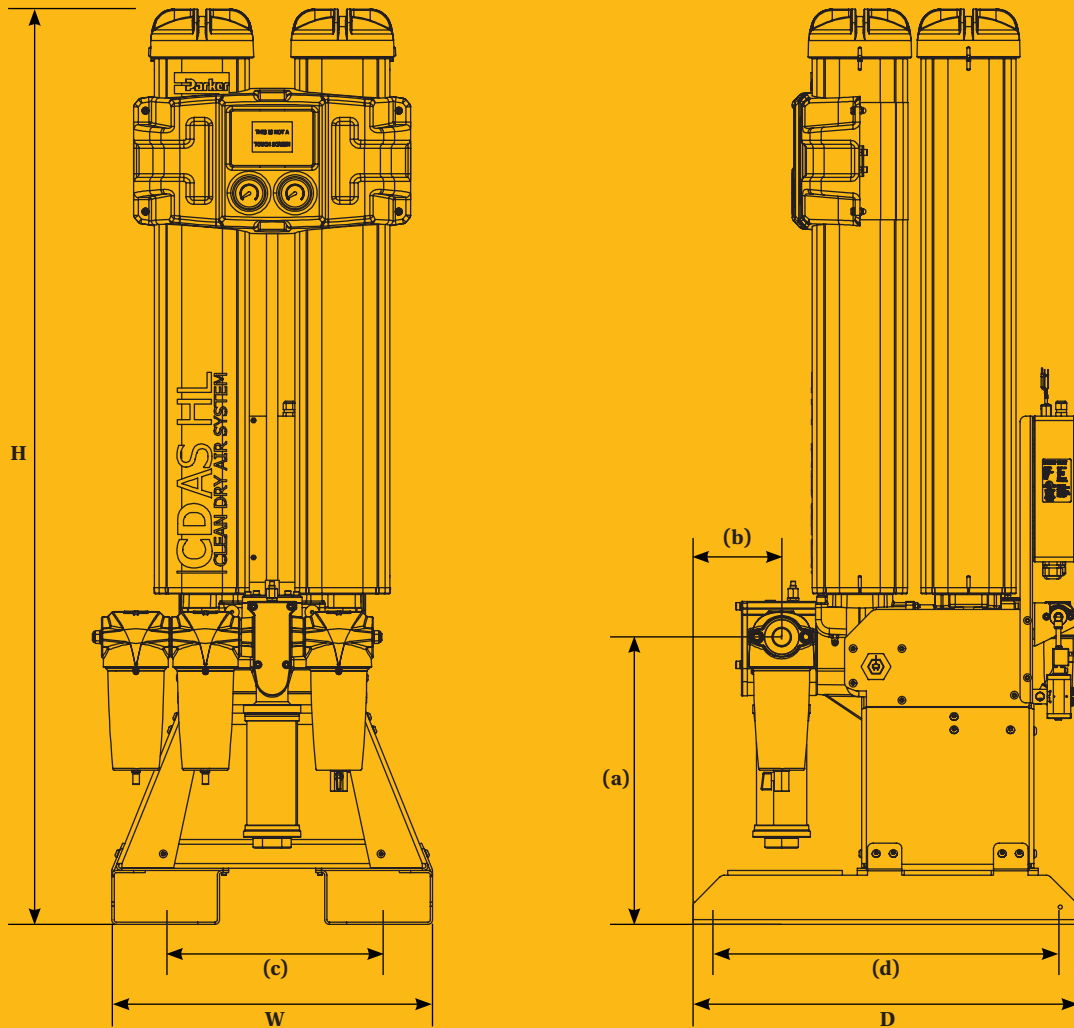

DRYER MODEL	DRYER DIMENSIONS														WEIGHT	
	H		W		D		(a)		(b)		(c)		(d)			
	MM	INS	MM	INS	MM	INS	MM	INS	MM	INS	MM	INS	MM	INS	KG	IBS
CDAS HL 050	1133	44.6	559	22.0	490	19.3	416	16.4	121.5	4.78	371.3	14.62	410	16.14	76	168
CDAS HL 055	1313	51.7	559	22.0	490	19.3	416	16.4	121.5	4.78	371.3	14.62	410	16.14	84	185
CDAS HL 060	1510	59.4	559	22.0	490	19.3	416	16.4	121.5	4.78	371.3	14.62	410	16.14	93	205
CDAS HL 065	1660	65.4	559	22.0	490	19.3	416	16.4	121.5	4.78	371.3	14.62	410	16.14	100	220
CDAS HL 070	2020	79.5	559	22.0	490	19.3	416	16.4	121.5	4.78	371.3	14.62	410	16.14	120	265
CDAS HL 075	1595	62.8	559	22.0	682	26.9	501	19.71	154	6.07	371.3	14.62	610	24.02	165	364
CDAS HL 080	1745	68.7	559	22.0	682	26.9	501	19.71	154	6.07	371.3	14.62	610	24.02	180	397
CDAS HL 085	2105	82.9	559	22.0	682	26.9	501	19.71	154	6.07	371.3	14.62	610	24.02	210	463

OFAS HL WEIGHTS AND DIMENSIONS

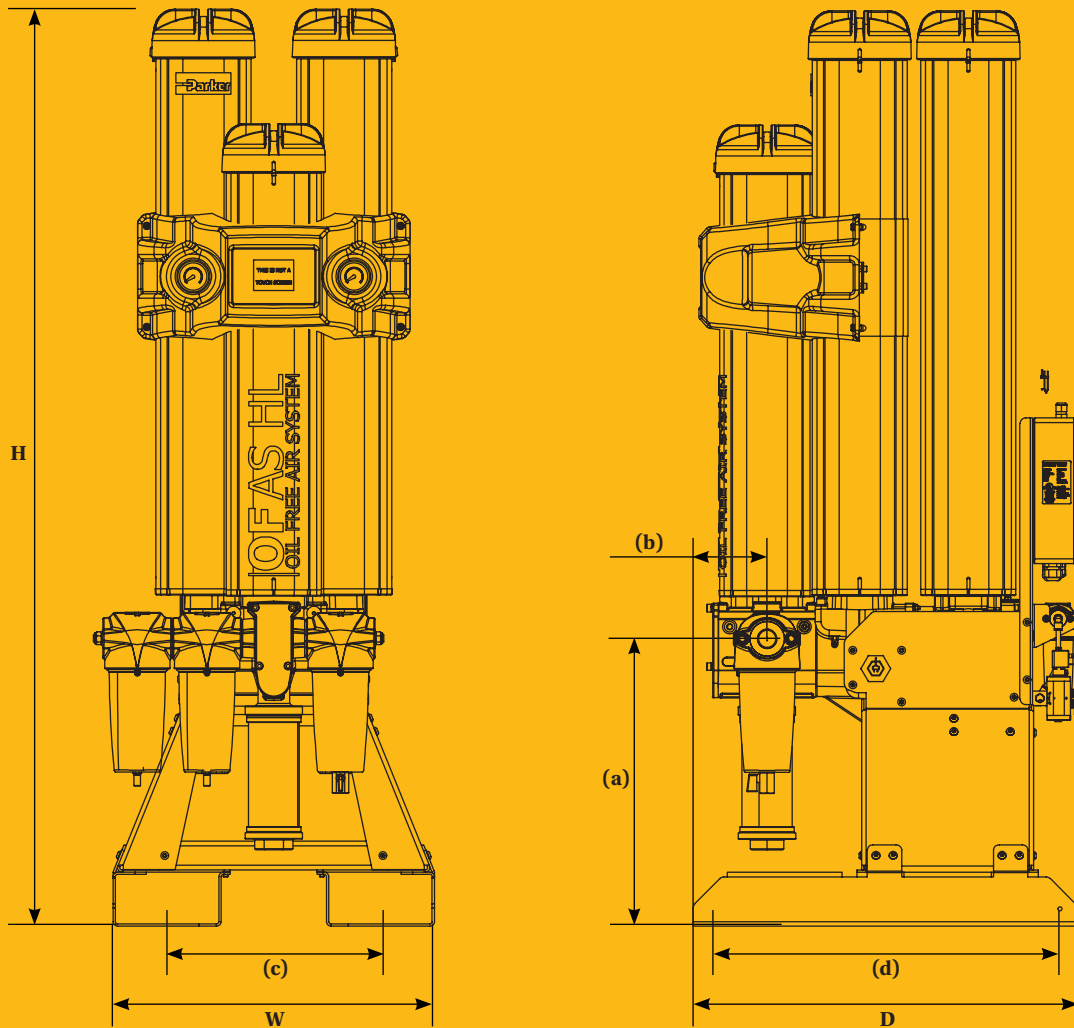

DRYER MODEL	DRYER DIMENSIONS														WEIGHT	
	H		W		D		(a)		(b)		(c)		(d)			
	MM	INS	MM	INS	MM	INS	MM	INS	MM	INS	MM	INS	MM	INS	KG	IBS
OFAS HL 050	1133	44.6	559	22.0	490	19.3	416	16.4	96.5	3.80	371.3	14.62	410	16.14	90	198
OFAS HL 055	1313	51.7	559	22.0	490	19.3	416	16.4	96.5	3.80	371.3	14.62	410	16.14	97	214
OFAS HL 060	1510	59.4	559	22.0	490	19.3	416	16.4	96.5	3.80	371.3	14.62	410	16.14	106	234
OFAS HL 065	1660	65.4	559	22.0	490	19.3	416	16.4	96.5	3.80	371.3	14.62	410	16.14	112	247
OFAS HL 070	2020	79.5	559	22.0	490	19.3	416	16.4	96.5	3.80	371.3	14.62	410	16.14	132	291
OFAS HL 075	1595	62.8	559	22.0	682	26.9	501	19.71	129	5.09	371.3	14.62	610	24.02	184	406
OFAS HL 080	1745	68.7	559	22.0	682	26.9	501	19.71	129	5.09	371.3	14.62	610	24.02	196	432
OFAS HL 085	2105	82.9	559	22.0	682	26.9	501	19.71	129	5.09	371.3	14.62	610	24.02	232	511

FBP HL WEIGHTS AND DIMENSIONS

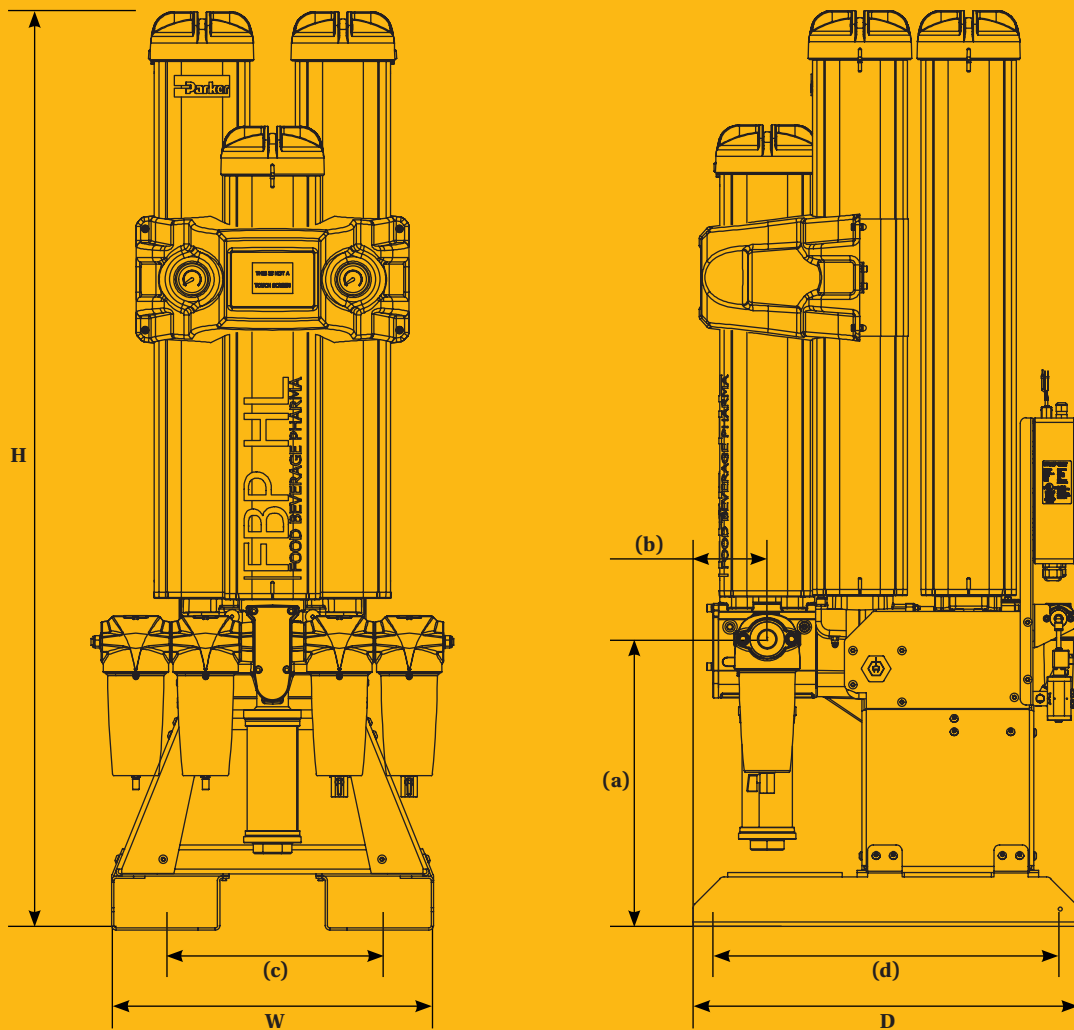

DRYER MODEL	DRYER DIMENSIONS														WEIGHT	
	H		W		D		(a)		(b)		(c)		(d)			
	MM	INS	MM	INS	MM	INS	MM	INS	MM	INS	MM	INS	MM	INS	KG	IBS
FBP HL 050	1133	44.6	559	22.0	490	19.3	416	16.4	96.5	3.80	371.3	14.62	410	16.14	91	201
FBP HL 055	1313	51.7	559	22.0	490	19.3	416	16.4	96.5	3.80	371.3	14.62	410	16.14	98	216
FBP HL 060	1510	59.4	559	22.0	490	19.3	416	16.4	96.5	3.80	371.3	14.62	410	16.14	108	238
FBP HL 065	1660	65.4	559	22.0	490	19.3	416	16.4	96.5	3.80	371.3	14.62	410	16.14	114	251
FBP HL 070	2020	79.5	559	22.0	490	19.3	416	16.4	96.5	3.80	371.3	14.62	410	16.14	136	300
FBP HL 075	1595	62.8	559	22.0	682	26.9	501	19.71	129	5.09	371.3	14.62	610	24.02	186	410
FBP HL 080	1745	68.7	559	22.0	682	26.9	501	19.71	129	5.09	371.3	14.62	610	24.02	198	437
FBP HL 085	2105	82.9	559	22.0	682	26.9	501	19.71	129	5.09	371.3	14.62	610	24.02	235	518

TROUBLESHOOTING

In the unlikely event that a problem occurs on the equipment, this troubleshooting guide can be used to identify the probable cause and remedy.



Warning

Troubleshooting should only be attempted by competent personnel. All major repair and calibration work should be undertaken by a Parker trained, qualified and approved engineer.

Dewpoint Failure

A dewpoint failure will result in there being water in the downstream piping and equipment

PROBABLE CAUSE	REMEDY
The inlet parameters have changed.	If the inlet flow-rate or the inlet temperature have increased ensure that the filters and dryer are re-sized accordingly. If the inlet pressure has changed ensure that the filters and dryer are re-sized accordingly.
The condensate is not being drained.	Verify that all condensate drains are functioning correctly. Check that the drain hoses are free from kinks and obstructions. Ensure that the isolation valves on the drains are fully open.
The compressor is not functioning correctly.	Check the documentation supplied by the compressor manufacturer for troubleshooting guidance.
The compressor capacity has changed.	Ensure that the filters and dryer are sized accordingly.
The after cooler is not functioning correctly.	Test that condensate drain is operating correctly. Check that the cooling water system is functioning correctly and that the water temperature is within specification (water cooled systems only). Ensure that the after cooler and dust filter (if fitted) are clean (air cooled systems only). Ensure that the fan is functioning correctly (air cooled systems only).
There is no wet air receiver fitted within the system.	Install a wet air receiver and drain within the system (if possible). Ensure there is adequate drainage on the piping prior to the dryer pre-filtration. A water separator should also be installed before the dryer pre-filtration to ensure removal of bulk liquid.
Filtration has not been correctly maintained.	If the element and float drain have been installed longer than 12 months ensure that they are both changed. Verify that the float drain is operating correctly.
The dryer has been by-passed.	If a bypass line has been installed on the system ensure that it is closed. Use bypass filtration.
The regeneration column pressure within the dryer is greater than 350mbar.	Contact a Parker approved service agent.
There is a fault with the dryer timer.	Contact a Parker approved service agent.
There is a fault with the dryer valves.	Contact a Parker approved service agent.
The desiccant is approaching the end of its useful life.	Contact a Parker approved service agent.

Loss of Outlet Dewpoint

<p>Confirm loss of dewpoint</p>	<p>Check outlet dewpoint downstream of the dryer with an external hygrometer.</p>	<p>If outlet dewpoint on external hygrometer does not match dewpoint on dryer display - check sensor the dryer dewpoint sensor</p>	
<p>Confirm dryer sizing</p>	<p>Check sizing (Max inlet flow rate, Min inlet pressure, Max inlet temperature)</p>	<p>Sizing correct, continue below. Sizing incorrect, install correctly sized dryer or correct inlet parameters.</p>	
<p>Confirm no liquid is present at inlet to coalescing filters</p>	<p>Check aftercooler drain operation. Check liquid separator drain operation. Check air receiver drain operation. Check condensate lines are not blocked & condensate is flowing correctly.</p>	<p>Coalescing filters are not designed for liquid removal (water & oil aerosols only). If upstream equipment drains are not operating correctly and / or condensate is not being discharged from these drains correctly, excessive liquid will be entering the inlet filters and overloading the dryer, leading to loss of dewpoint If no wet air receiver is fitted in the compressed air system before the dryer, an optional WS grade water separator should always be installed prior to the coalescing filters.</p>	
<p>Confirm pre-filtration drains are operating correctly</p>	<p>Check General Purpose Coalescing Filter Float Drain Operation Check High Efficiency Coalescing Filter Float Drain Operation Check condensate lines are not blocked & condensate is flowing correctly. If an optional WS grade water separator is fitted, check float drain operation.</p>	<p>If the drains fitted to the dryer pre filters (and optional WS if fitted) are not operating correctly and / or condensate is not being discharged correctly, excessive liquid will be entering the dryer, resulting in loss of dewpoint.</p>	
<p>Confirm purge setting</p>	<p>Check purge has been set for the MINIMUM inlet pressure to the dryer.</p>	<p>Purge is factory set for 6 bar g and must be reset on commissioning to the minimum inlet pressure into the dryer. Incorrectly set purge will result in insufficient purge to regenerate the desiccant material, resulting in loss of outlet dewpoint or excessive purge resulting in insufficient compressed air downstream, dropping system pressure and potentially overloading the dryer leading to loss of dewpoint</p>	
<p>Check dryer is cycling correctly (all valves are functioning)</p>	<p>Check dryer is cycling between each column Check the dryer is depressurising when required Check the dryer is purging when required Check the dryer is repressurising when required</p>	<p>If dryer does not changeover, ensure both inlet cylinders are operating correctly (check 5/2 valve operation, individual cylinder operation and seals) If dryer does not depressurise, ensure exhaust valve is operating correctly (check 5/2 valve operation, exhaust cylinder operation and seals) If the pressure gauge for the column undergoing regeneration (purging) shows a pressure >350mbar, ensure exhaust silencer is not blocked (check 5/2 valve operation, cylinder operation and seals) If dryer does not repressurise, ensure exhaust valve is operating correctly (check 5/2 valve operation, cylinder operation and seals) If dryer does not repressurise fully before changeover, ensure correct purge setting and check QRV valve operation</p>	<p>Normal Function Changeover Column A drying Exhaust valve open Column B depressurised Column B purging - no dP on gauges Exhaust valve closes Column B repressurises and reaches full line pressure before changeover After 3 minutes, if dewpoint < setpoint, dryer enters EST, ECO shown on screen Dewpoint set-point reached Changeover</p>
		<p>LED's illuminated on the solenoid plug's but dryer fails to cycle correctly</p>	<p>Check when the LED is illuminated that 24VDC is at the output of the plug Check the condition of the spool valve for smooth movement.</p>

Loss of Outlet Dewpoint Continued...

Check Parker Dewpoint Sensor	Check the Parker Dewpoint Sensor is clean	Remove any particulate with low pressure compressed air	
Check cartridge sealing	<p>Check cartridge sealing on column showing low dewpoint</p> <p>Check cartridge sealing on column showing low dewpoint</p>	<p>Switch off dryer once both columns have depressurised</p> <p>Depressurise Dryer</p> <p>Remove column top caps</p> <p>Remove cartridges</p> <p>Check cartridge seals are intact</p> <p>Check cartridge seals are in wave groove</p> <p>Reseat cartridges carefully</p> <p>Replace column top caps</p> <p>Introduce pressure slowly</p> <p>Restart dryer</p> <p>Check dewpoint for recovery</p>	
Check condition of outlet check valve ball	Check outlet check ball for deterioration / deformation	<p>Switch off dryer</p> <p>Depressurise Dryer</p> <p>Remove check valve ball cover plate</p> <p>Inspect ball for deterioration / deformation</p> <p>Replace if necessary</p> <p>Replace cover plate</p> <p>Introduce pressure slowly</p> <p>Restart dryer</p> <p>Check dewpoint for recovery</p>	
Check for back flow	Check a non return valve is installed at dryer outlet	<p>Check purge assembly for blockage & clean if necessary</p> <p>Check QRV for blockage and clean if necessary</p> <p>Check desiccant cartridge for signs of carbon dust (OFAS/FBP)</p>	

High Pressure drop

A high pressure drop will result in low pressure gauge readings or intermittent operation of the downstream equipment.

PROBABLE CAUSE	REMEDY
Filtration has not been correctly maintained.	If the element and float drain have been installed longer than 12 months ensure that they are both changed. Verify that the float drain is operating correctly.
The inlet parameters have changed.	If the inlet flow-rate has increased ensure that the filters and dryer are re-sized accordingly. If the inlet temperature has increased verify that the filters are within specification. Ensure that the oil vapour removal filters and the dryer are re-sized accordingly. If the inlet pressure has changed ensure that the filters and dryer are re-sized accordingly. Contact Parker for details on particle counting and air quality air measurement.
The compressor is not functioning correctly.	Check the documentation supplied by the compressor manufacturer for troubleshooting guidance.
There is a pressure loss from the system.	Check for leaks in the piping and at connection points. Ensure that all drain cocks and pressure relief valves are closed. Check to see if the downstream flow-rate demand has increased.
The dryer is not powered up.	Verify that the dryers power indicator is illuminated. If the dryer is not powered check the isolator and circuit breaker.
An isolation valve is closed or partially closed.	Check the position of all isolation valves.

Downstream air supply interrupted

An interruption of the air supply downstream will result in a rapid loss of system pressure and failure of the downstream equipment.

PROBABLE CAUSE	REMEDY
Filtration has not been correctly maintained. The compressor is not functioning correctly.	Check the documentation supplied by the compressor manufacturer for troubleshooting guidance.
There is a pressure loss from the system.	Check for leaks in the piping and at connection points.
The dryer is not powered up.	Verify that the dryers power indicator is illuminated. If the dryer is not powered check the isolator and circuit breaker. Check the dryer fault indicators.

UK Declaration of Conformity

EN

Parker Hannifin Manufacturing Limited GSFE
Dukesway, Team Valley Trading Estate, Gateshead, Tyne & Wear, NE11 0PZ, UK

Compressed Air Dryer

CDASHL050, CDASHL055, CDASHL060, CDASHL065, CDASHL070,
CDASHL075, CDASHL080, CDASHL085
OFASHL050, OFASHL055, OFASHL060, OFASHL065, OFASHL070,
OFASHL075, OFASHL080, OFASHL085

Regulations

PE(S)R 2016 (as amended) SI 2016 No. 1105
EE(S)R 2016 (as amended)
ECR 2016 (as amended)

Standards used

PE(S)R Generally in accordance with
ASME VIII Div 1 : 2021

EE(S)R BS EN 61010-1 : 2010

ECR BS EN 61326-1 : 2013

PE(S)R Assessment Route: Module B + D

PE(S)R Certificate Number COV0912556/1

PE(S)R Approved Body Number Approval Body Number: 0038
LRQA Verification Limited, 1 Trinity Park, Bickenhill Lane, Birmingham.
B37 7ES

Authorised Representative Steven Rohan

Parker Hannifin Manufacturing Limited GSFE

Declaration

This declaration of conformity issued under the sole responsibility of the manufacturer and the essential safety requirements have been demonstrated and fulfilled in respect of the pressure equipment

Signature:



Date: 28 March 2022

Declaration Number:

00300 / 28.3.22

EU Declaration of Conformity

EN

Parker Hannifin Manufacturing Limited GSFE
Dukesway, Team Valley Trading Estate, Gateshead, Tyne & Wear, NE11 0PZ, UK

Compressed Air Dryer

CDASHL050, CDASHL055, CDASHL060, CDASHL065, CDASHL070,
CDASHL075, CDASHL080, CDASHL085
OFASHL050, OFASHL055, OFASHL060, OFASHL065, OFASHL070,
OFASHL075, OFASHL080, OFASHL085

Directives	PED	2014/68/EU
	LVD	2014/35/EU
	EMC	2014/30/EU

Standards used	PED	Generally in accordance with ASME VIII Div 1 : 2021
	LVD	EN 61010-1 : 2010
	EMC	EN 61326-1 : 2013

PED Assessment Route: Module B + D

PED Certificate Number 50351

Notified body for PED: Notified Body Number: 0525
Lloyd's Register Deutschland GmbH
Überseeallee 10,
D-20457 Hamburg, Deutschland

Authorised Representative Steven Rohan

Parker Hannifin Manufacturing Limited GSFE

Declaration

This declaration of conformity issued under the sole responsibility of the manufacturer and the essential safety requirements have been demonstrated and fulfilled as set out in Annex 1

Signature: 

Date: 28 March 2022

Declaration Number:
00300 / 28.3.22

UK Declaration of Conformity

EN

Parker Hannifin Manufacturing Limited GSFE
Dukesway, Team Valley Trading Estate, Gateshead, Tyne & Wear, NE11 0PZ, UK
Food, Beverage, Pharmaceuticals Compressed Air Dryer

FBPHL050, FBPHL055, FBPHL060, FBPHL065, FBPHL070, FBPHL075, FBPHL080, FBPHL085

Regulations
PE(S)R 2016 (as amended) SI 2016 No. 1105
EE(S)R 2016 (as amended)
ECR 2016 (as amended)

Standards used
PE(S)R Generally in accordance with
ASME VIII Div 1 : 2021
EE(S)R BS EN 61010-1 : 2010
ECR BS EN 61326-1 : 2013

PE(S)R Assessment Route: Module B + D

PE(S)R Certificate Number COV0912556/1

PE(S)R Approved Body Number Approval Body Number: 0038
LRQA Verification Limited, 1 Trinity Park, Bickenhill Lane, Birmingham.
B37 7ES

Authorised Representative Steven Rohan

Parker Hannifin Manufacturing Limited GSFE

Declaration

This declaration of conformity issued under the sole responsibility of the manufacturer and the essential safety requirements have been demonstrated and fulfilled in respect of the pressure equipment

Signature:



Date: 28 March 2022

Declaration Number:
00305 / 28.3.22

EU Declaration of Conformity

EN

Parker Hannifin Manufacturing Limited GSFE
Dukesway, Team Valley Trading Estate, Gateshead, Tyne & Wear, NE11 0PZ, UK
Food, Beverage, Pharmaceuticals Compressed Air Dryer

FBPHL050, FBPHL055, FBPHL060, FBPHL065, FBPHL070, FBPHL075, FBPHL080, FBPHL085

Directives

PED	2014/68/EU
LVD	2014/35/EU
EMC	2014/30/EU

Standards used

PED	Generally in accordance with ASME VIII Div 1 : 2021
LVD	EN 61010-1 : 2010
EMC	EN 61326-1 : 2013

PED Assessment Route: Module B + D

PED Certificate Number 50351

Notified body for PED: Notified Body Number: 0525
Lloyd's Register Deutschland GmbH
Überseeallee 10,
D-20457 Hamburg, Deutschland

Authorised Representative Steven Rohan

Parker Hannifin Manufacturing Limited GSFE

Declaration

This declaration of conformity issued under the sole responsibility of the manufacturer and the essential safety requirements have been demonstrated and fulfilled as set out in Annex 1

Signature:



Date: 28 March 2022

Declaration Number:
00305 / 28.3.22

PARKER WORLDWIDE

AE – UAE, Dubai

Tel: +971 4 8127100
parker.me@parker.com

AR – ARGENTINA, Buenos Aires

Tel: +54 3327 44 4129

AT – AUSTRIA, Wiener Neustadt

Tel: +43 (0)2622 23501-0
parker.austria@parker.com

AT – EASTERN EUROPE,

Wiener Neustadt
Tel: +43 (0)2622 23501 900
parker.easteurope@parker.com

AU – AUSTRALIA, Castle Hill

Tel: +61 (0)2-9634 7777

AZ – AZERBAIJAN, Baku

Tel: +994 50 2233 458
parker.azerbaijan@parker.com

BE/LU – BELGIUM, Nivelles

Tel: +32 (0)67 280 900
parker.belgium@parker.com

BR – BRAZIL, Cachoeirinha RS

Tel: +55 51 3470 9144

BY – BELARUS, MINSK

Tel: +375 17 209 9399
parker.belarus@parker.com

CA – CANADA, Milton, Ontario

Tel: +1 905 693 3000

CH – SWITZERLAND, Etoy

Tel: +41 (0)21 821 87 00
parker.switzerland@parker.com

CL – CHILE, Santiago

Tel: +56 2 623 1216

CN – CHINA, Shanghai

Tel: +86 21 2899 5000

CZ – CZECH REPUBLIC, Klecany

Tel: +420 284 083 111
parker.czechrepublic@parker.com

DE – GERMANY, Kaarst

Tel: +49 (0)2131 4016 0
parker.germany@parker.com

DK – DENMARK, Ballerup

Tel: +45 43 56 04 00
parker.denmark@parker.com

ES – SPAIN, Madrid

Tel: +34 902 330 001
parker.spain@parker.com

FI – FINLAND, Vantaa

Tel: +358 (0)20 753 2500
parker.finland@parker.com

FR – FRANCE, Contamine s/Arve

Tel: +33 (0)4 50 25 80 25
parker.france@parker.com

GR – GREECE, Athens

Tel: +30 210 933 6450
parker.greece@parker.com

HK – Hong Kong

Tel: +852 2428 8008

HU – HUNGARY, Budapest

Tel: +36 1 220 4155
parker.hungary@parker.com

IE – IRELAND, Dublin

Tel: +353 (0)1 466 6370
parker.ireland@parker.com

IN – INDIA, Mumbai

Tel: +91 22 6513 7081-85

IT – ITALY, Corsico (MI)

Tel: +39 02 45 19 21
parker.italy@parker.com

JP – JAPAN, Tokyo

Tel: +81 (0)3 6408 3901

KR – SOUTH KOREA, Seoul

Tel: +82 2 559 0400

KZ – KAZAKHSTAN, Almaty

Tel: +7 7272 505 800
parker.easteurope@parker.com

LV – LATVIA, Riga

Tel: +371 6 745 2601
parker.latvia@parker.com

MX – MEXICO, Apodaca

Tel: +52 81 8156 6000

MY – MALAYSIA, Shah Alam

Tel: +60 3 7849 0800

NL – The Netherlands,

Oldenzaal
Tel: +31 (0)541 585 000
parker.nl@parker.com

NO – NORWAY, Asker

Tel: +47 66 75 34 00
parker.norway@parker.com

NZ – NEW ZEALAND, Mt Wellington

Tel: +64 9 574 1744

PL – POLAND, Warsaw

Tel: +48 (0)22 573 24 00
parker.poland@parker.com

PT – PORTUGAL, Leca da Palmeira

Tel: +351 22 999 7360
parker.portugal@parker.com

RO – ROMANIA, Bucharest

Tel: +40 21 252 1382
parker.romania@parker.com

SE – SWEDEN, Spånga

Tel: +46 (0)8 59 79 50 00
parker.sweden@parker.com

SG – Singapore

Tel: +65 6887 6300

SK – SLOVAKIA, Banská Bystrica

Tel: +421 484 162 252
parker.slovakia@parker.com

SL – SLOVENIA, Novo Mesto

Tel: +386 7 337 6650
parker.slovenia@parker.com

TH – THAILAND, Bangkok

Tel: +662 717 8140

TR – TURKEY, Istanbul

Tel: +90 216 4997081
parker.turkey@parker.com

TW – TAIWAN, Taipei

Tel: +886 2 2298 8987

UA – UKRAINE, Kiev

Tel: +380 44 494 2731
parker.ukraine@parker.com

UK – UNITED KINGDOM,

Warwick
Tel: +44 (0)1926 317 878
parker.uk@parker.com

US – USA, Cleveland

Tel: +1 216 896 3000

VE – VENEZUELA, Caracas

Tel: +58 212 238 5422

ZA – SOUTH AFRICA,

Kempton Park
Tel: +27 (0)11 961 0700
parker.southafrica@parker.com

**European Product
Information Centre**

Free phone: 00 800 27 27 5374

(from AT, BE, CH, CZ, DE, EE,
ES, FI, FR, IE, IL, IS, IT, LU, MT,
NL, NO, PT, SE, SK, UK)

PARKER HANNIFIN MANUFACTURING LIMITED

Gas Separation and Filtration Division EMEA
Dukesway, Team Valley Trading Est
Gateshead, Tyne and Wear
England NE11 0PZ

Tel: +44 (0) 191 402 9000

Fax: +44 (0) 191 482 6296

www.parker.com/gsfe

